













## 2021 INSTALLATION GUIDE FOR FENCES, GATES & BALUSTRADES

Composite fences, gates & balustrades by Arbour Landscape Solutions are easy to install whilst offering a long-lasting & stylish solution.

Please ensure installation is followed as per the installation guide for Arbour Landscape Solutions warranty to apply.

### Posts in the Ground

## Fencing Component list

Image	Quantity per bay	Product Description	Dimensions	Weight
<b>1.8m x 1.8m Fence (sunk in the ground) FY- F1</b>				
	1	1. 2.4m post	70mm x 70mm x 2400mm	7.4kg
	1	2. Post cap		
	1	3. 1.815m Insert		
	1	4. 55mm Insert		
	1	5. 20 mm insert		
	1	Bottom Rail	1748mm x 30mm x 20mm	0.8kg
	1	Top Rail	1748mm x 30mm x 20mm	0.7kg
	1	1 Pack (4 Included with screws)	25mm x 24mm x 2mm	0.02kg
	12	FSC 100% Composite Fence boards	145mm x 1755mm x 19.5mm	3.85kg e.a.
<b>Additional Finishing post FY- PA1</b>				
	1	Additional post kit as above to finish end of run	70mm x 70mm x 2400mm	7.4kg
<b>4ft Fence (sunk into the ground) FY-F3</b>				
	1	1. 1815mm post	70mm x 70mm x 1815mm	8.5kg
	1	2. Post cap		
	1	3. 20mm Insert		
	1	4. 55mm Insert		
	1	5. 1185mm Insert		
	1	Bottom Rail	1748mm x 30mm x 20mm	0.8kg
	1	Top Rail	1748mm x 30mm x 20mm	0.7kg
	1	1 Pack (4 Included & Screws)		0.02kg
	8	FSC 100% Composite Fence boards	145mm x 1755mm x 19.5mm	3.85kg e.a.
<b>Additional Finishing post FY- PA2</b>				
		Additional post kit to finish	70mm x 70mm x 1815mm	8.5kg

1



Dig a sufficient sized hole in the ground to accept the post allowing for the desired fence height.

2

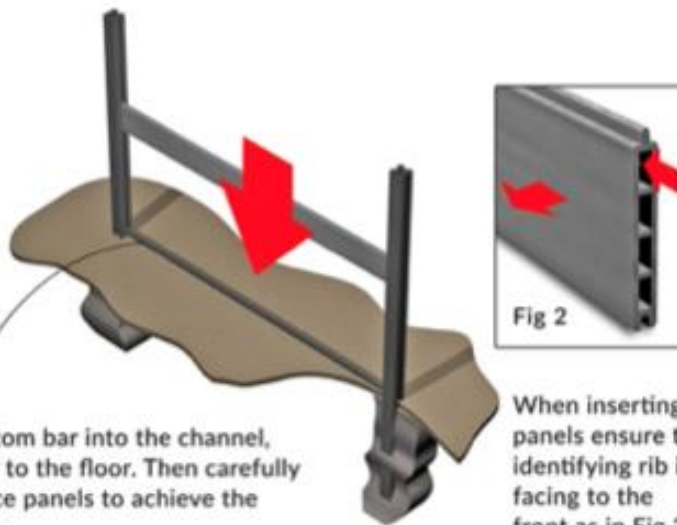

Insert the bottom bar into the channel, sliding the bar to the floor. Then carefully insert the fence panels to achieve the desired height.

When inserting panels ensure the identifying rib is facing to the front as in Fig 2.

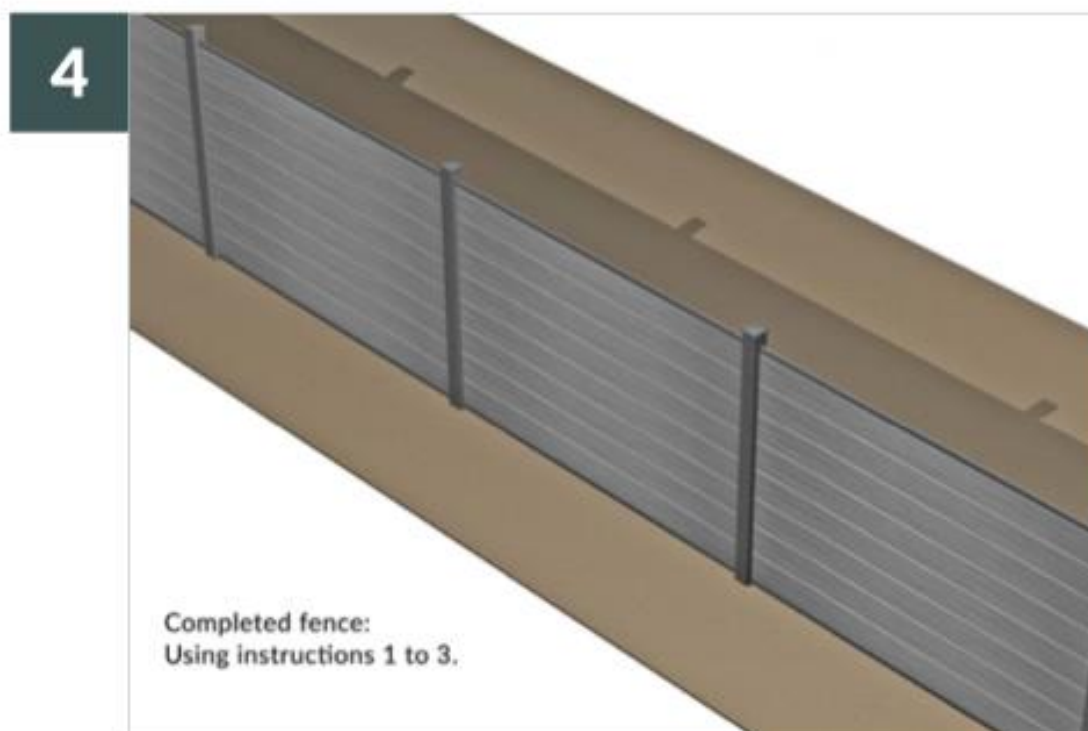
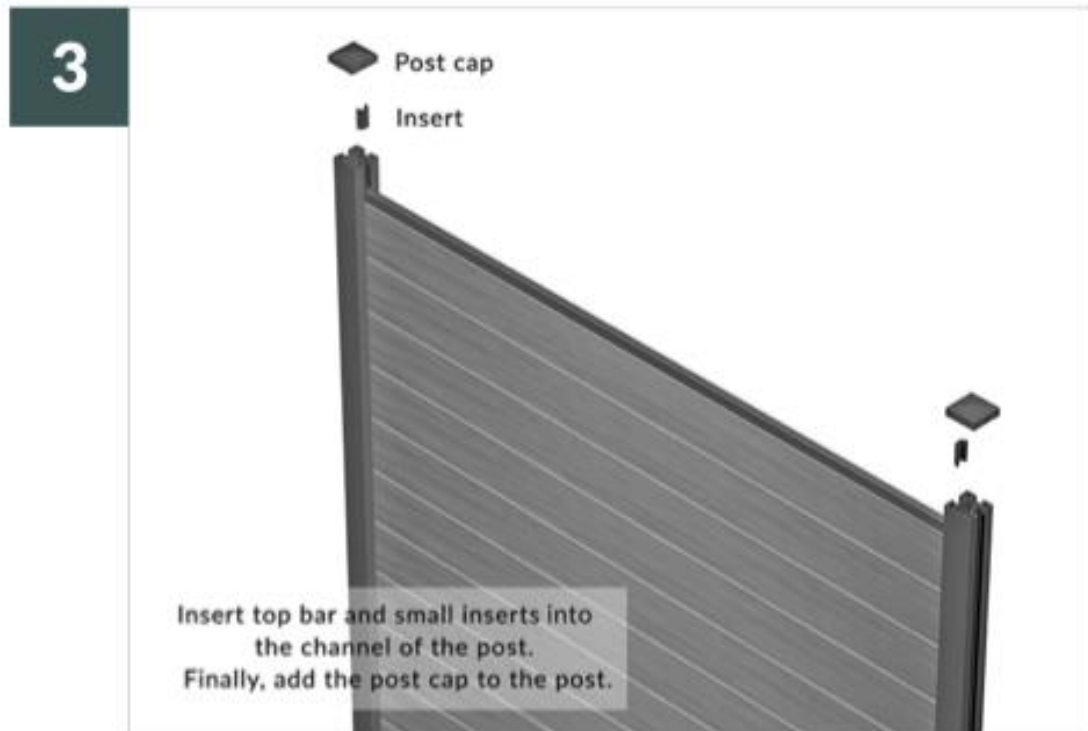

## Posts with base plates

### Fencing Component list

















Image	Quantity per bay	Product Description	Dimensions	Weight
<b>1.8m x 1.8m Fence (with baseplates) FY-F2</b>				
	1	1. 1815mm post	70mm x 70mm x 1815mm	8.5kg
	1	2. Post cap		
	1	3. 20mm Insert		
	1	4. 55mm Insert		
	1	5. 1185mm Insert		
	1	Bottom Rail	1748mm x 30mm x 20mm	0.8kg
	1	Top Rail	1748mm x 30mm x 20mm	0.7kg
	1	10mm baseplate	130mm x 130mm x 10mm	2.5kg
	4	Bolts to attach baseplate to post		
	4	Concrete fixing bolts		
	1	1 Pack (4 Included with screws)	25mm x 24mm x 2mm	0.02kg
	12	FSC 100% Composite Fence boards	145mm x 1755mm x 19.5mm	3.85kg e.a.
<b>Additional Finishing post FY- PA2 and baseplate FY-BP1</b>				
	1	Additional post kit to finish	70mm x 70mm x 1815mm	4.8kg
	1	Additional baseplate to finish	130mm x 130mm x 10mm	2.5kg

Image	Quantity per bay	Product Description	Dimensions	Weight
<b>4ft Fence (with baseplates) FY- F4</b>				<b>38.1kg</b>
	1	1. 1.54mm post	70mm x 70mm x 1540 mm	4.8kg
	1	2. Post cap		
	1	3. 1540mm Insert		
	1	4. 55mm Insert		
	1	5. 1.54mm Post		
	1	Bottom Rail	1748mm x 30mm x 20mm	0.8kg
	1	Top Rail	1748mm x 30mm x 20mm	0.7kg
	1	Baseplate	130mm x 130mm x 10mm	2.5kg
	1	1 Pack (4 Included with screws)	25mm x 24mm x 2mm	0.02kg
	8	FSC 100% Composite Fence boards	145mm x 1755mm x 19.5mm	3.85kg e.a.
<b>Additional Finishing post FY- PA3 and Baseplate FY-BP1</b>				
	1	Additional post kit to finish	70mm x 70mm x 1540mm	4.8kg
	1	Additional baseplate to finish	130mm x 130mm x 10mm	2.5kg

1



2

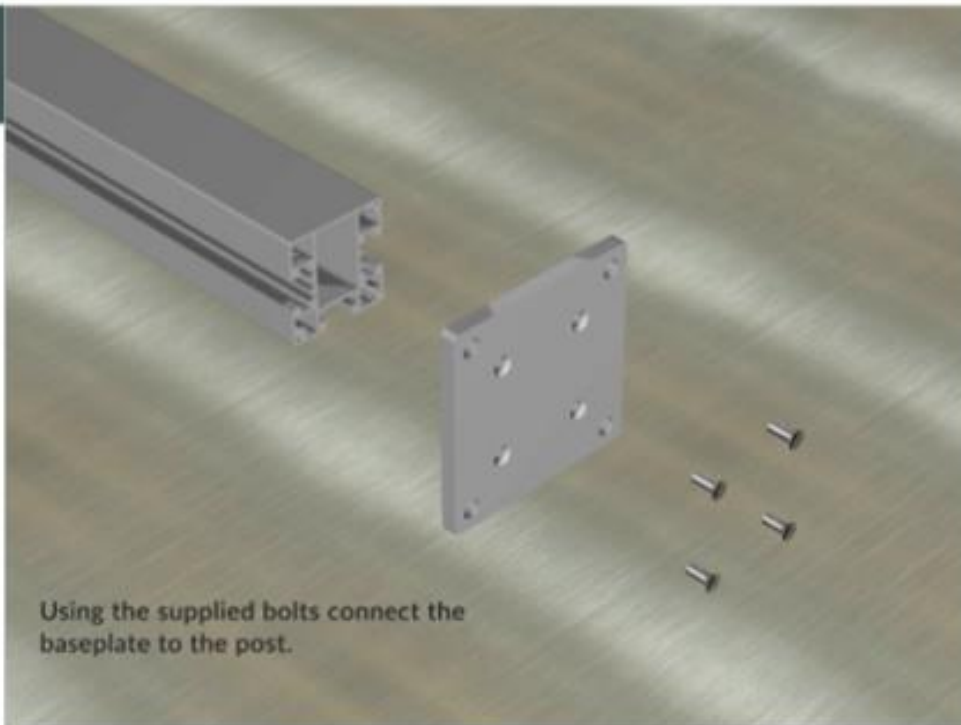
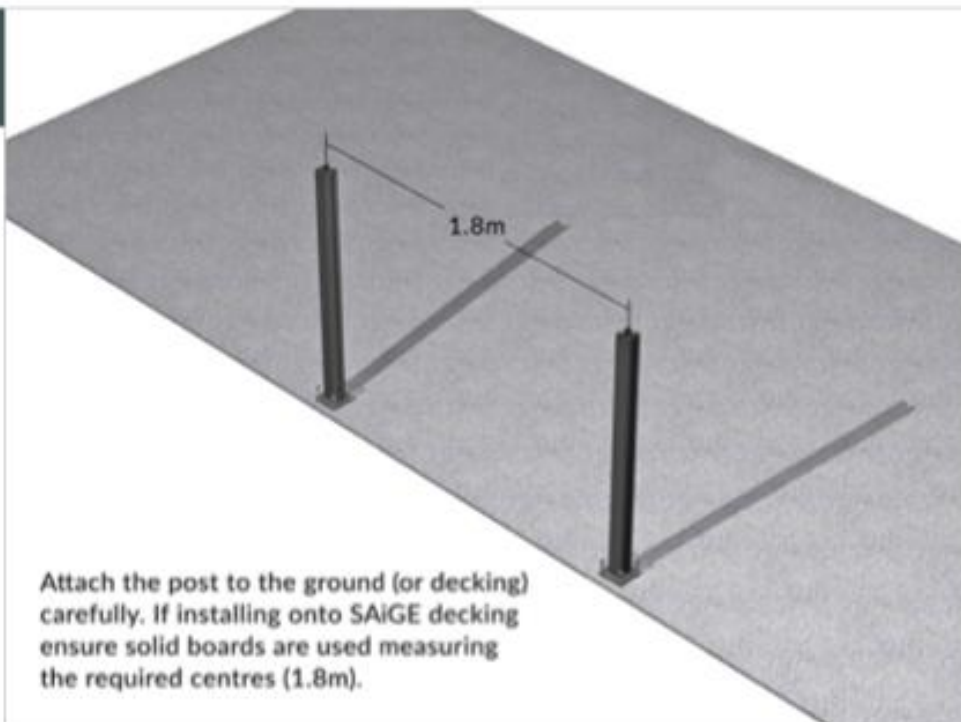

3

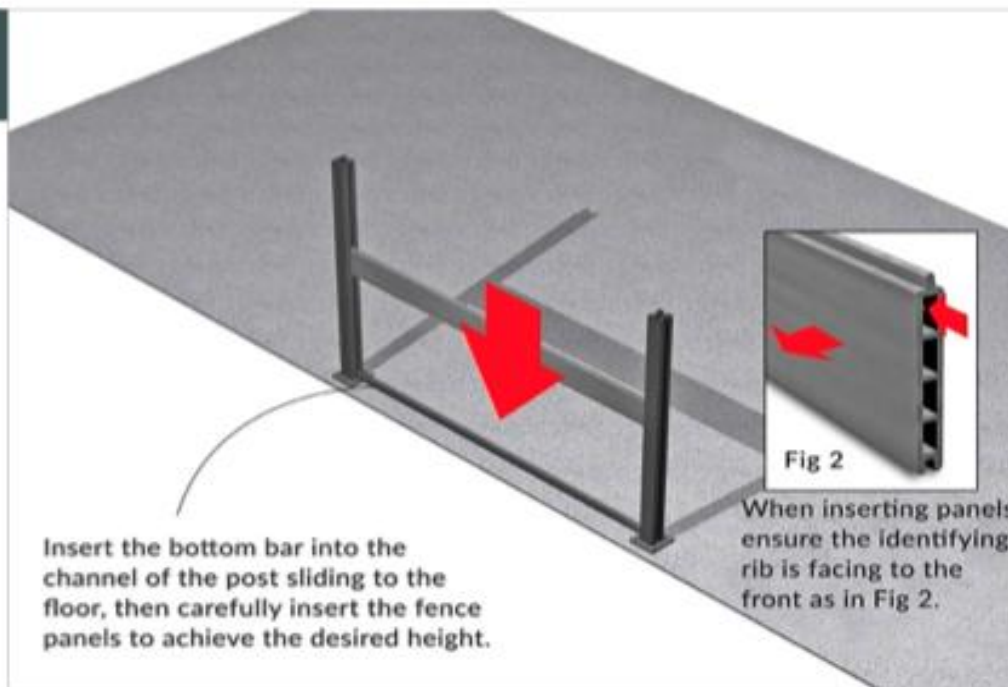

4

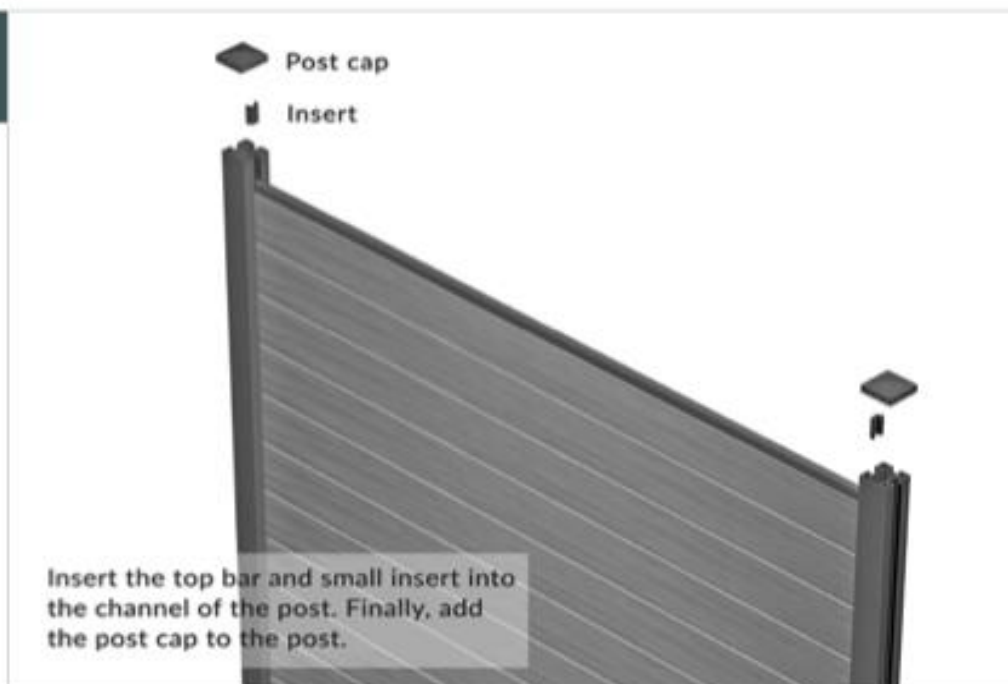



T : 020 8953 6177 • MarkhamClose  
E: enquiries@arboursolutions.co.uk  
www.arboursolutions.co.uk

5

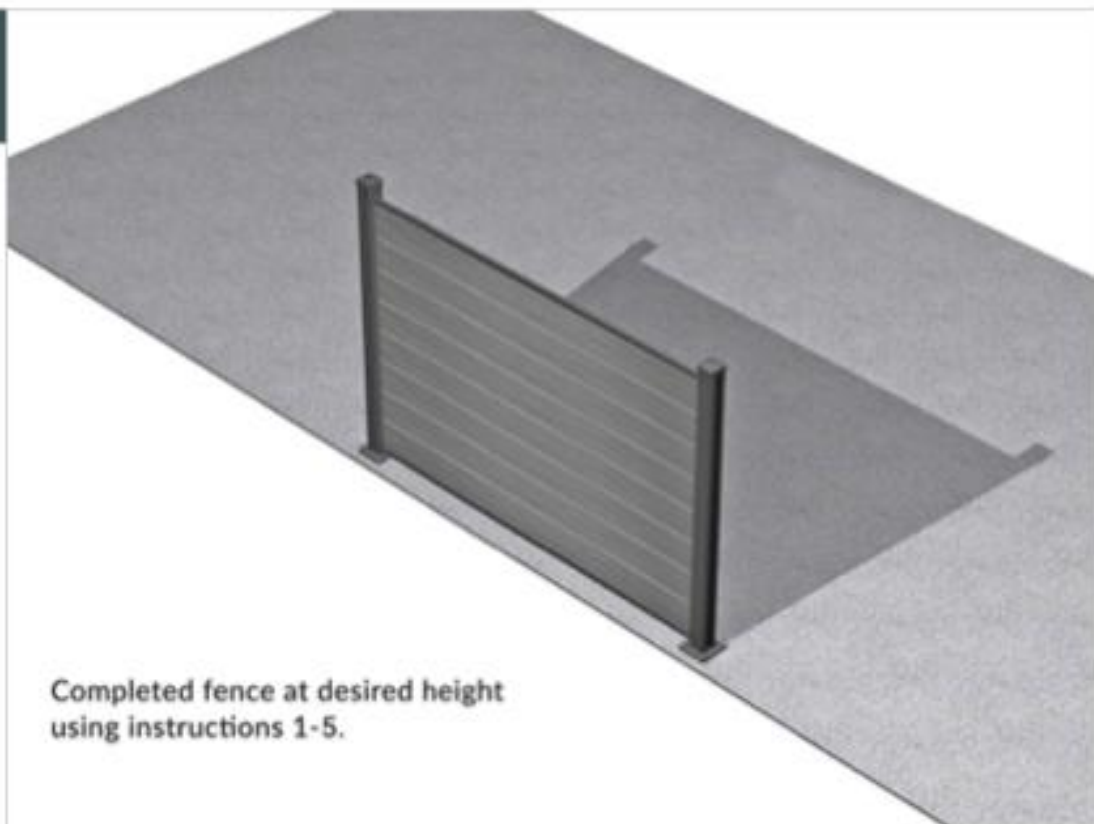









Completed fence at desired height  
using instructions 1-5.

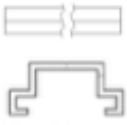

## Ranch style – 2 & 3 board options available.

### Ranch Style Fence Component list

Image	Quantity per bay	Product Description	Dimensions	Weight
<b>3 Board Ranch Fence (can be sunk in the ground or fixed using baseplates) FY-F7</b>				<b>21.75kg</b>
	1	1. 1.54m post	70mm x 70mm x 1540mm	4.8kg
	1	2. Post cap		
	1	3. 1540mm Insert		
	1	4. 55mm Insert		
	3	Bottom Rail	1748mm x 30mm x 20mm	0.8kg e.a.
	3	Top Rail	1748mm x 30mm x 20mm	0.7kg e.a.
	3	1 Pack (4 Included & Screws)	25mm x 24mm x 2mm	0.02kg
	3	FSC 100% Composite Fence boards	145mm x 1755mm x 19.5mm	3.85kg e.a.
	1	Baseplate if sinking into the ground	130mm x 130mm x 10mm	2.5kg
	1	1155mm Insert	1155mm	0.4kg
<b>Additional Finishing post FY- PA3 and baseplate FY-PB1</b>				
	1	Additional post kit to finish	70mm x 70mm x 1540mm	4.8kg
	1	Additional baseplate to finish	130mm x 130mm x 10mm	2.5kg

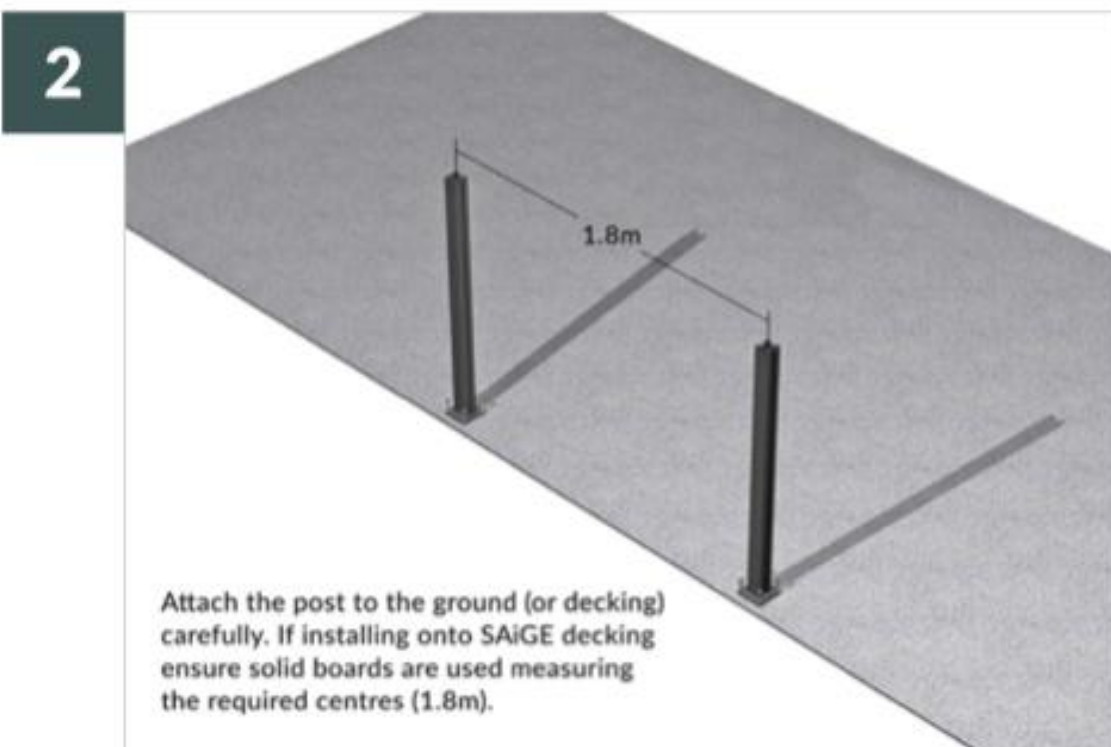
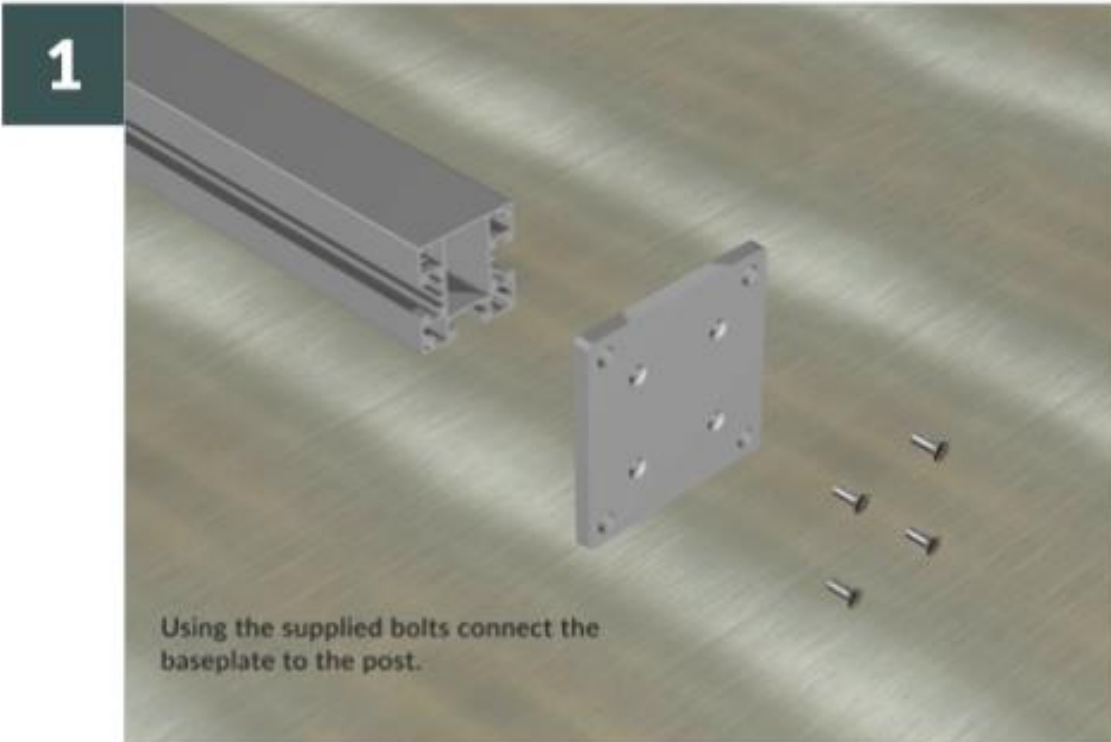

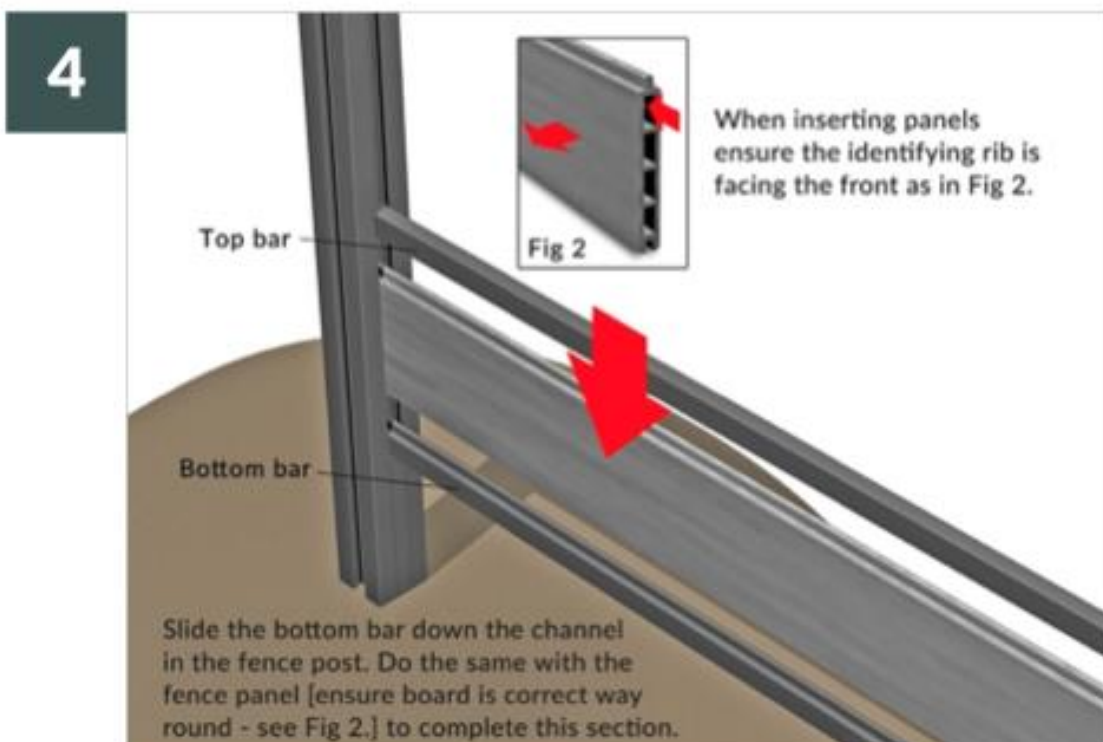
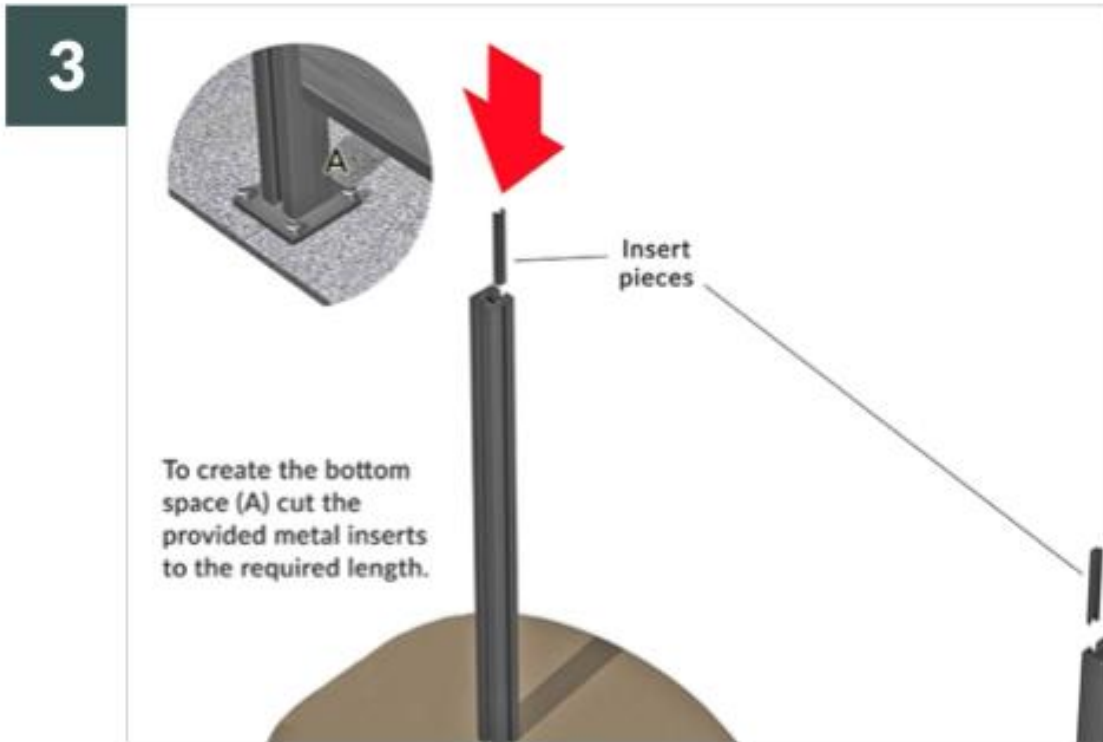

5

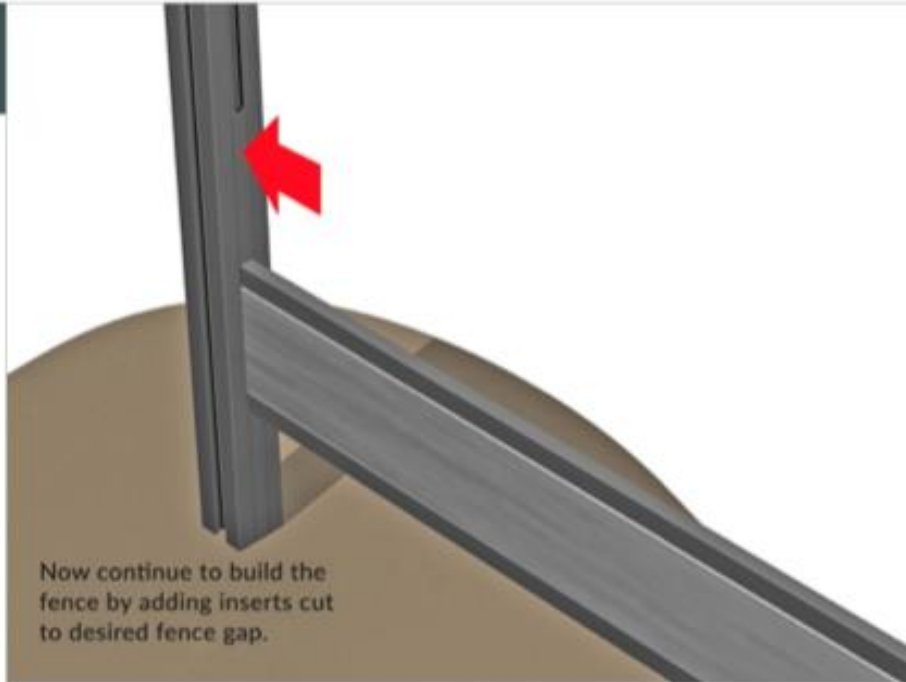

6

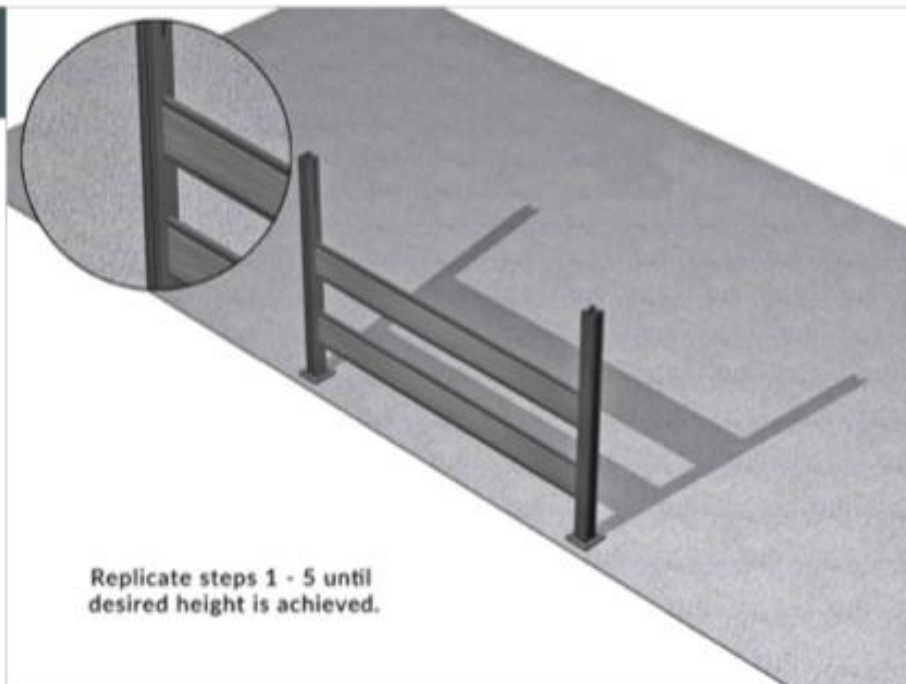

7

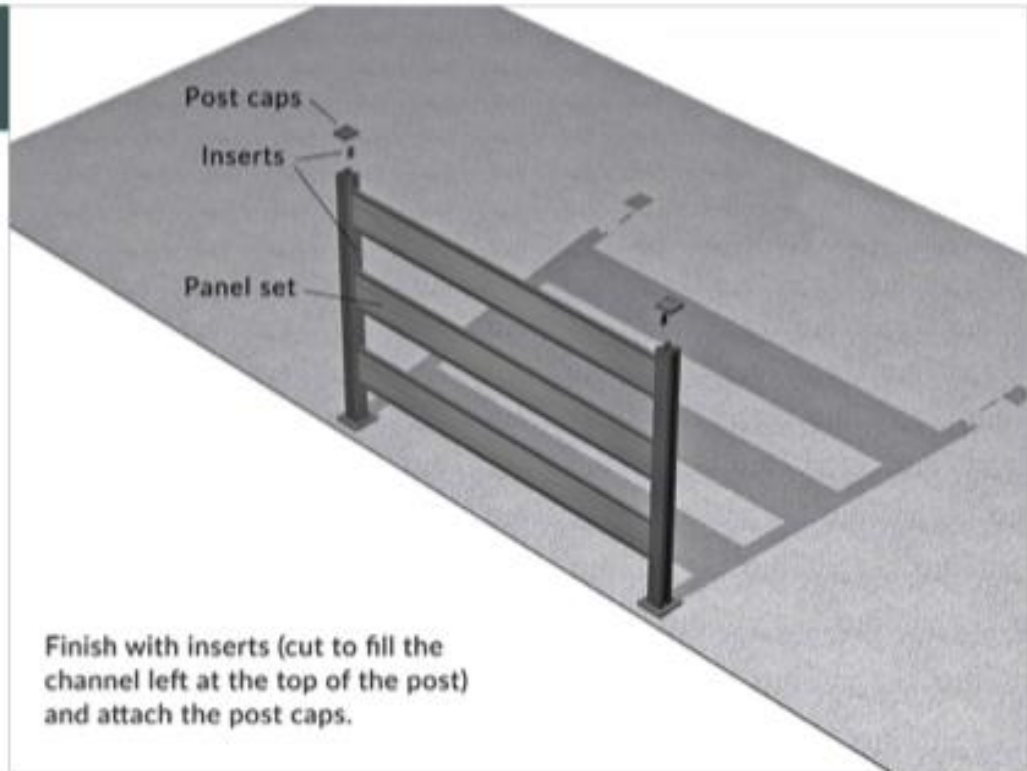

8

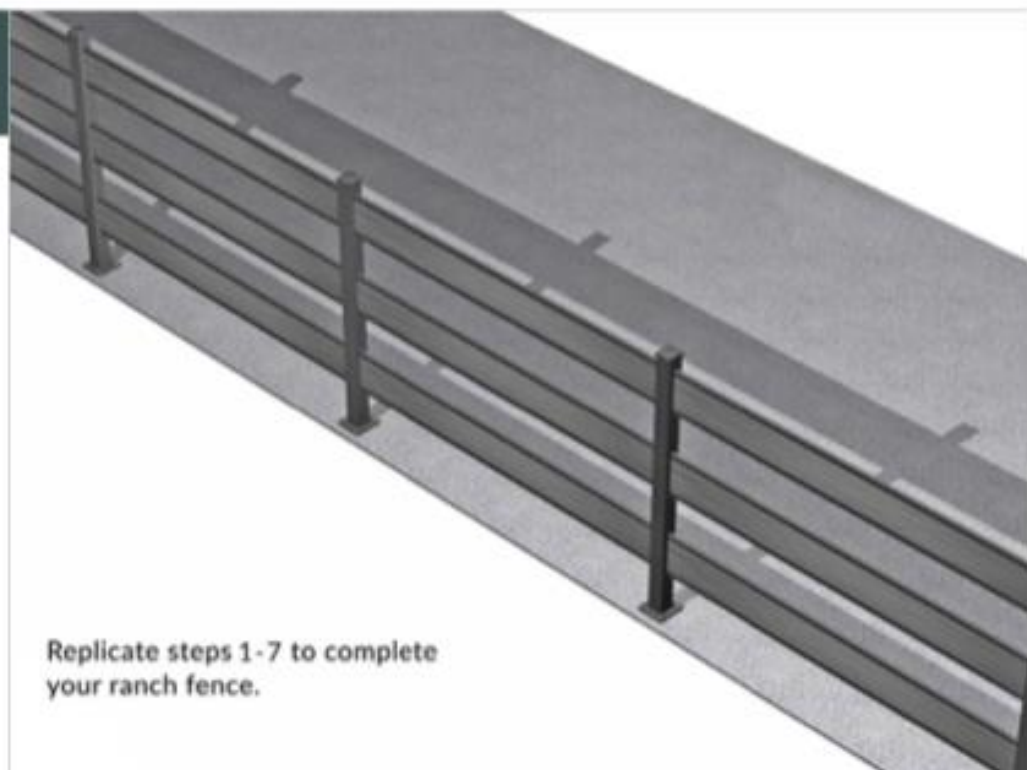

## Retro fit posts

1

Attach retro fit post insert to concrete post channel. The insert must be fixed to the post.



2

Position bottom bar into the retrofit post insert and slide down to bottom of the post.

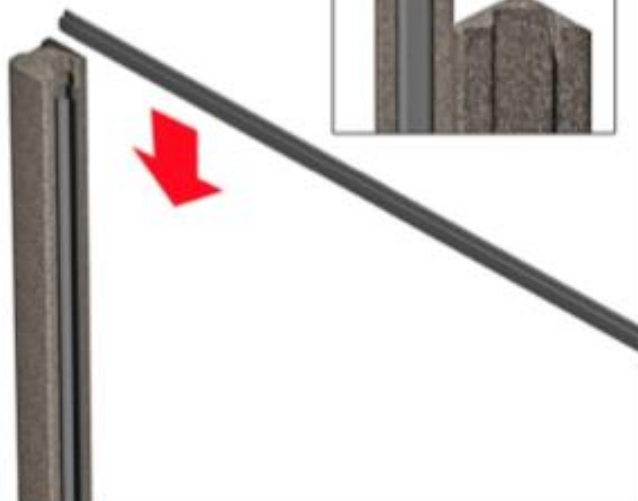

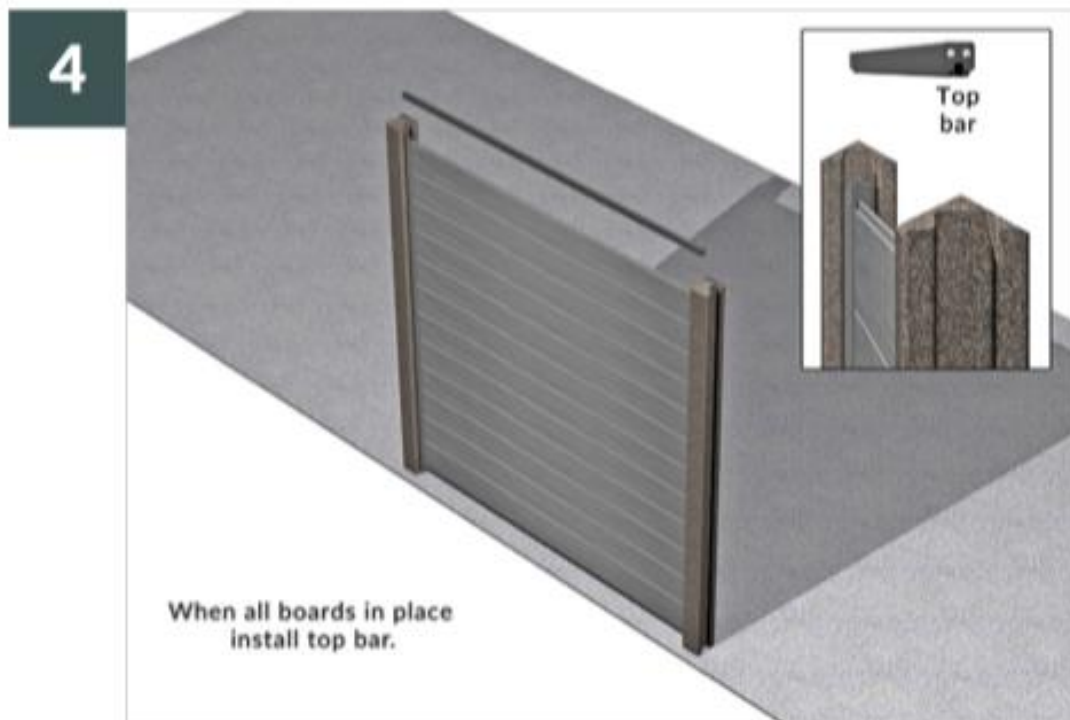
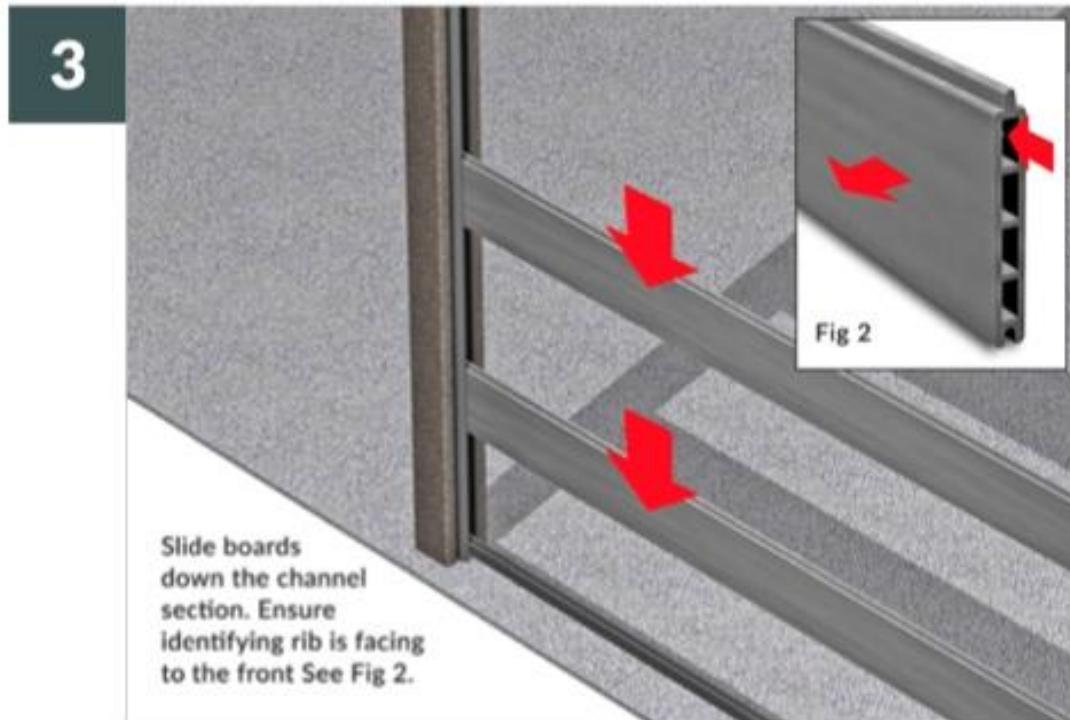

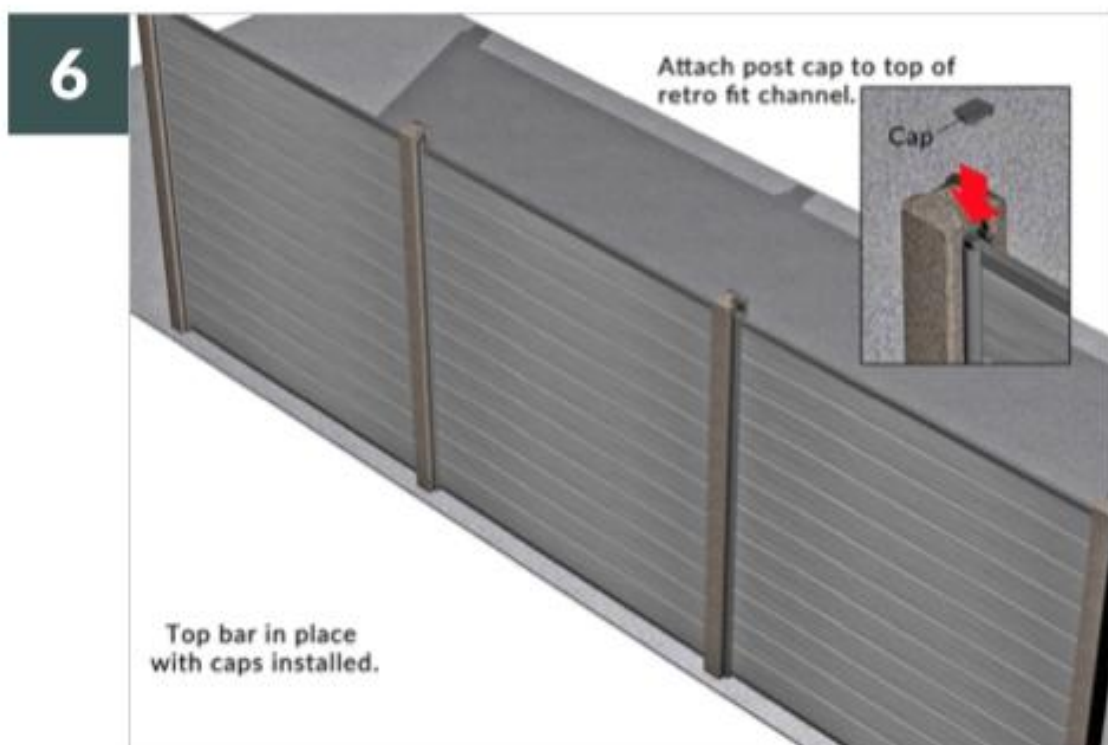
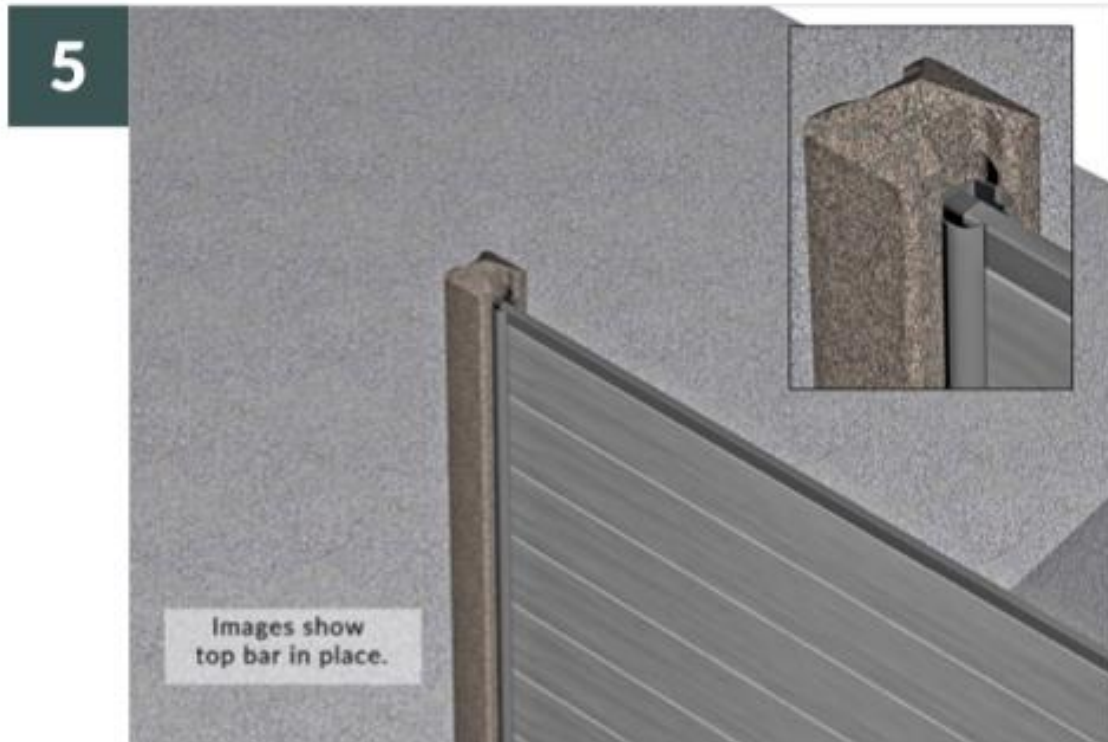







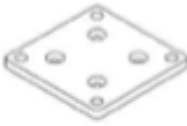

## Straight balustrade

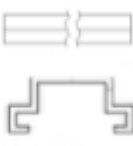
### Balustrade Component list

Image	Quantity per bay	Product Description	Dimensions	Weight
<b>Straight Balustrade FY-B1</b>				<b>28.2kg</b>
	1	1. 1.155m post	70mm x 70mm x 1155mm	3.5kg
	1	2. Post cap		
	2	3. 983mm Insert		
	1	4. 1155mm Insert		
	4	5. 55mm Insert		
	1	Top Handrail	1730mm x 45mm x 45mm	2.4kg
	1	Bottom Rail		
	1	10mm baseplate	130mm x 130mm x 10mm	2.5kg
	4	Bolts to attach baseplate to post		
	4	Concrete fixing bolts		
	26	T Bracket and screws	20mm x 17mm x 36mm	0.035kg e.a.
	11	FSC 100% Composite Spindles	955mm x 50mm x 30mm	1.2kg e.a.
	20	Insert 118.4mm	118.4mm	0.03kg e.a.
	4	55 mm Insert	55mm	0.01kg e.a.
	4	107.5 mm Insert	107.5mm	0.03kg e.a.
Top and Bottom rails come assembled with all T brackets and inserts fitted.				
<b>Additional Finishing post FY- PBA1 and baseplate FY-BP1</b>				
	1	Additional post kit to finish	70mm x 70mm x 1155mm	3.5kg
	1	Additional baseplate to finish	130mm x 130mm x 10mm	2.5kg

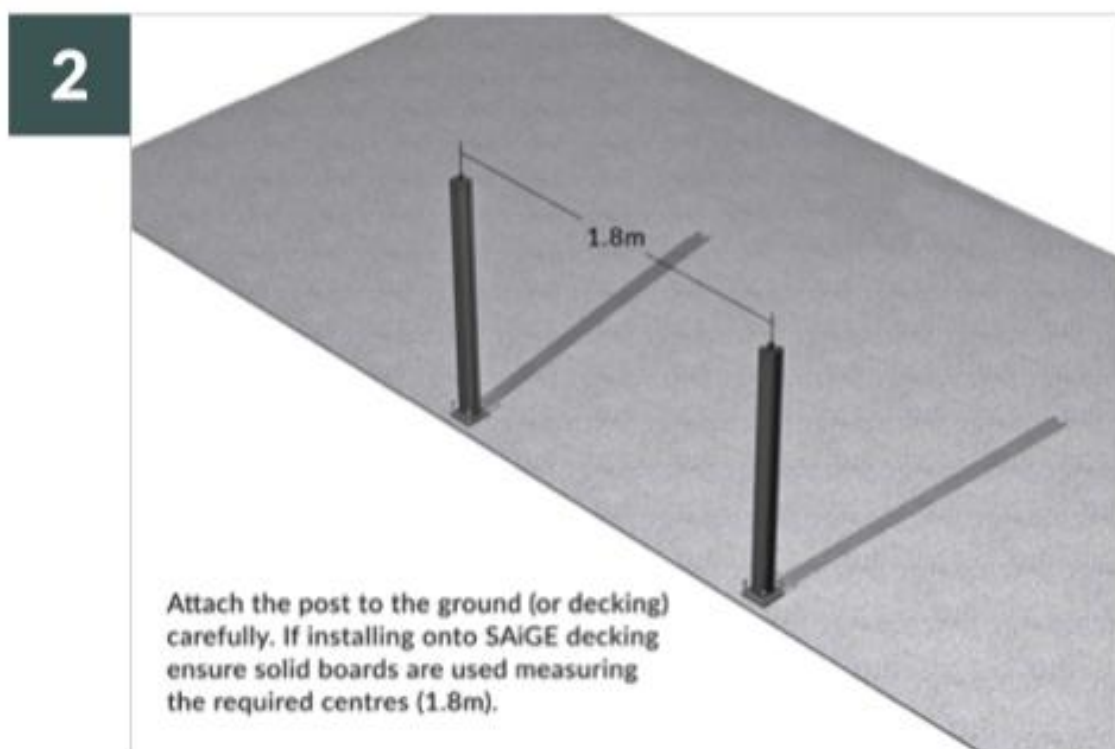
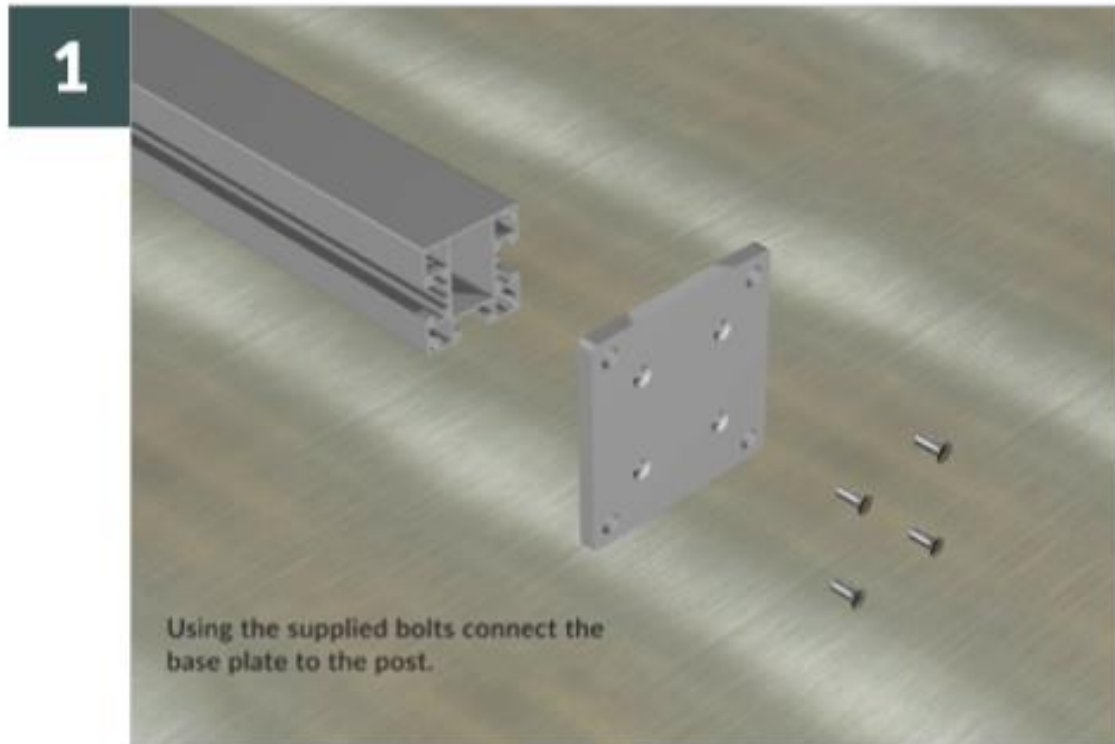

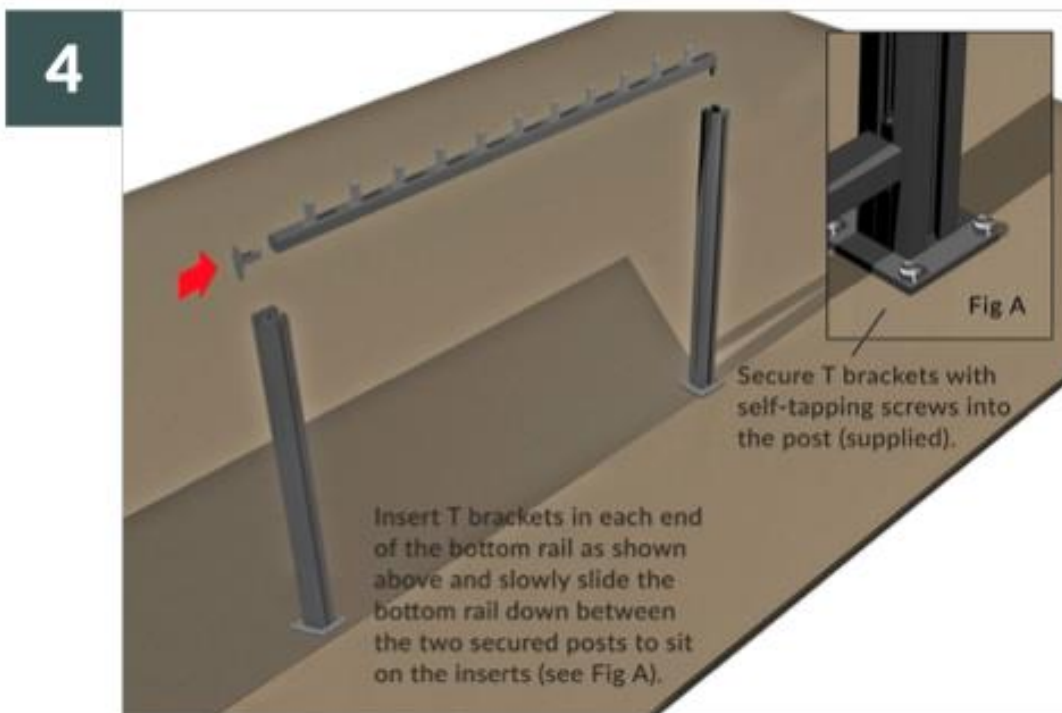
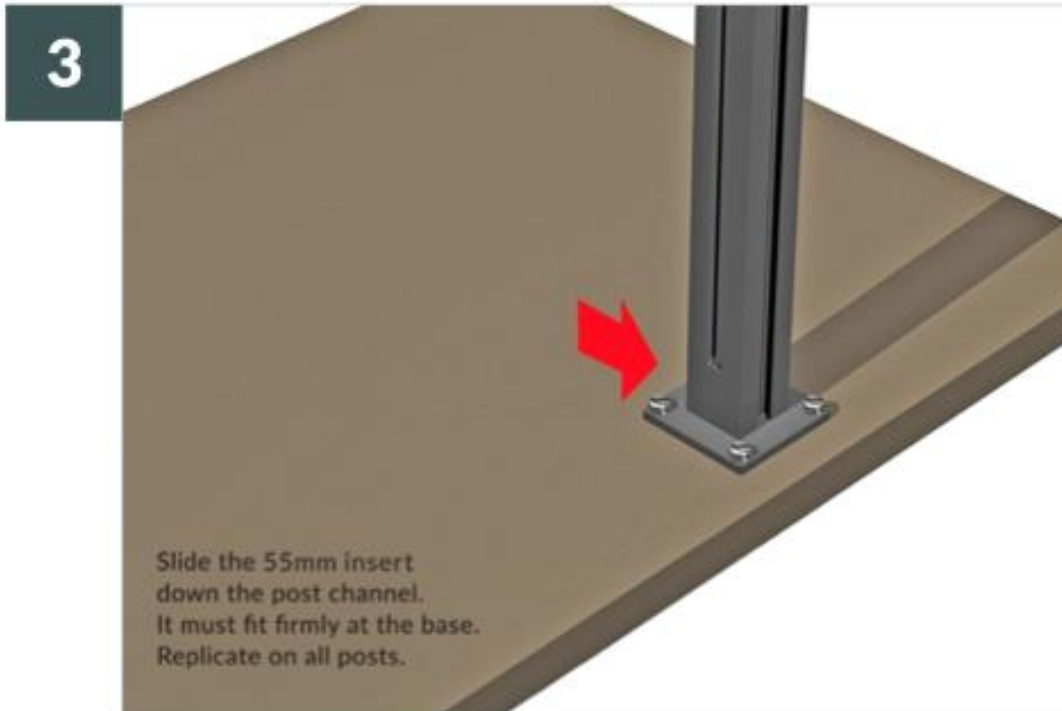

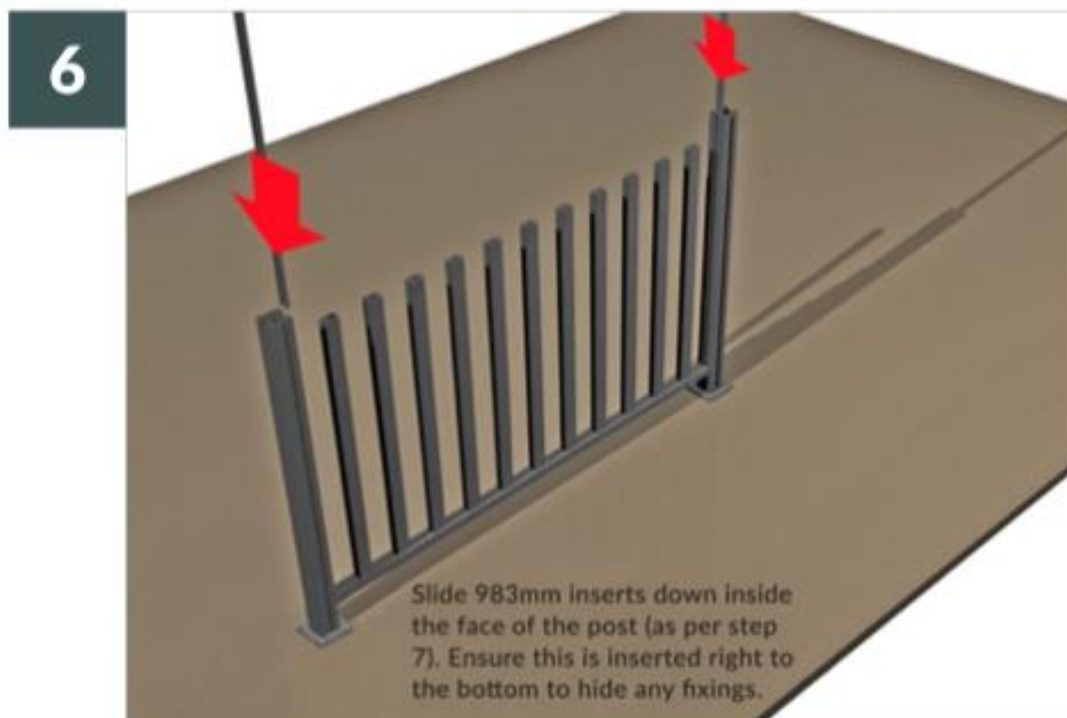
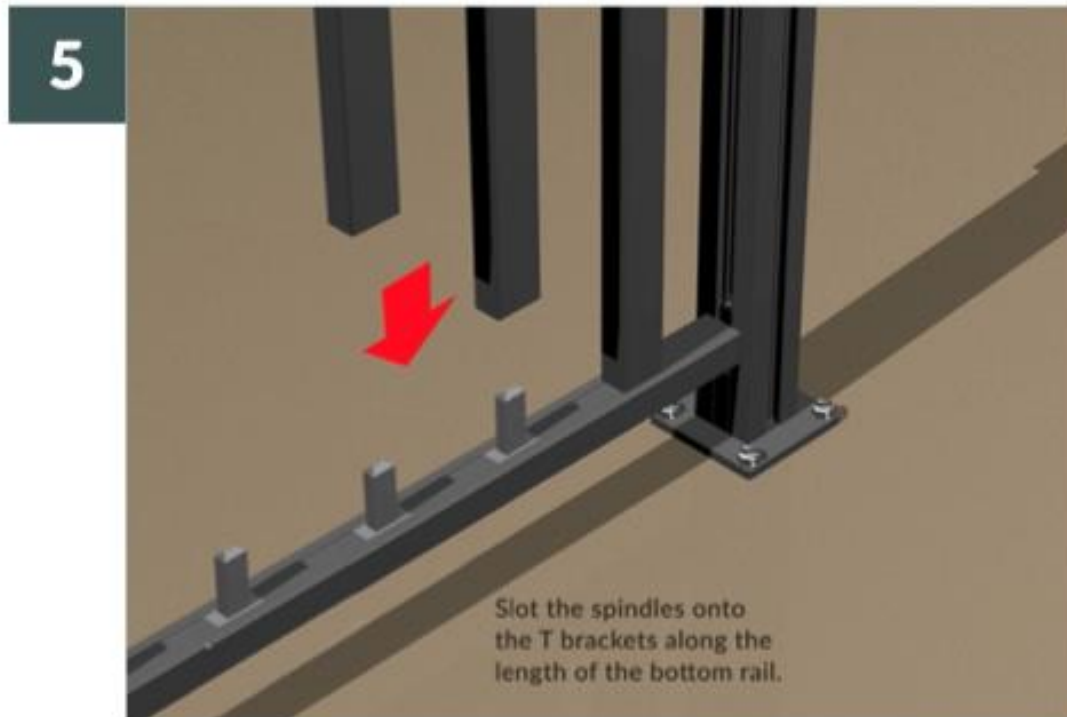

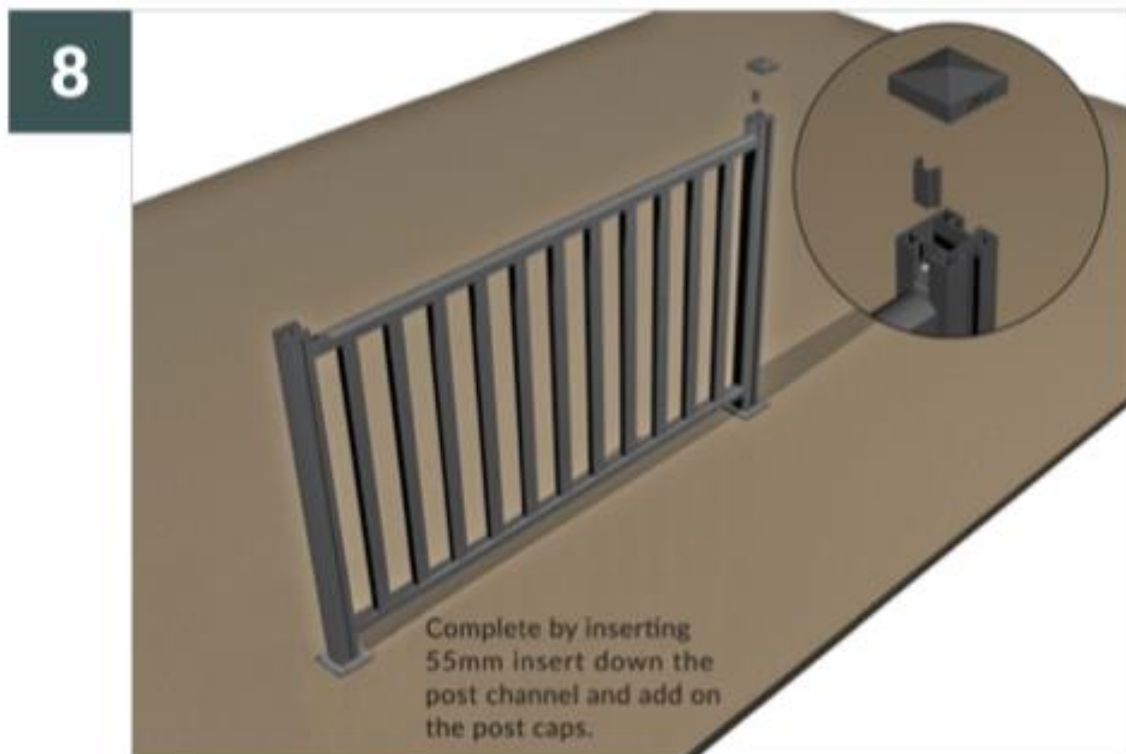
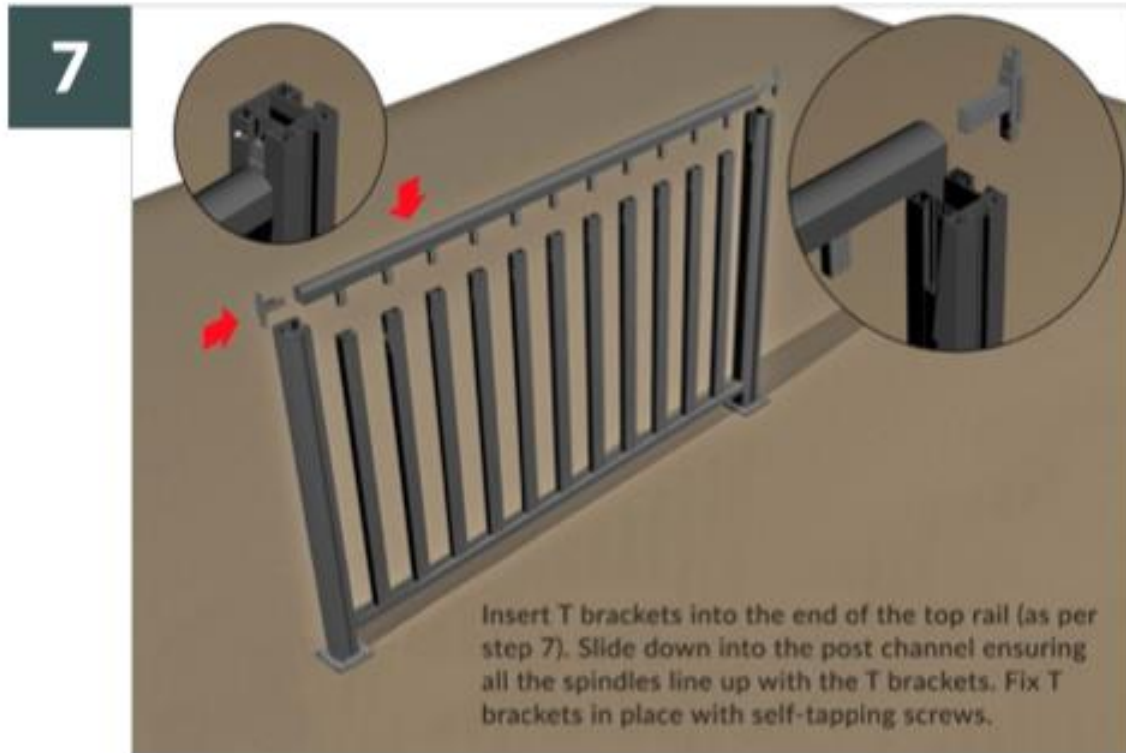



## Staircase balustrade

Image	Quantity per bay	Product Description	Dimensions	Weight
<b>Staircase Balustrade FY-B2</b>				<b>33.61kg</b>
	1	1. 1.2m post	70mm x 70mm x 1200mm	3.7kg
	1	2. Post cap		
	1	3. 983mm insert		
	4	4. 55mm insert		
	2	5. 1.2m insert		
	1	1. 1.155m post	70mm x 70mm x 1155mm	4.1kg
	1	2. post cap		
	4	3. 55mm insert		
	2	4. 983mm insert		
	1	5. 1155mm insert		
	1	Top Rail	1730mm x 45mm x 45mm	2.4kg
	1	Bottom Rail		
	2	10mm baseplates	130mm x 130mm x 10mm	2.5kg
	8	Bolts to attach baseplate to post		
	8	Concrete fixing bolts		
	26	Angled T Bracket and screws	24mm x 17mm x 48mm	0.05kg e.a.
	11	1m FSC 100% Composite Spindles	1000mm x 50mm x 30mm	1.26kg e.a.
Top and Bottom rails come assembled with all T brackets and inserts fitted.				

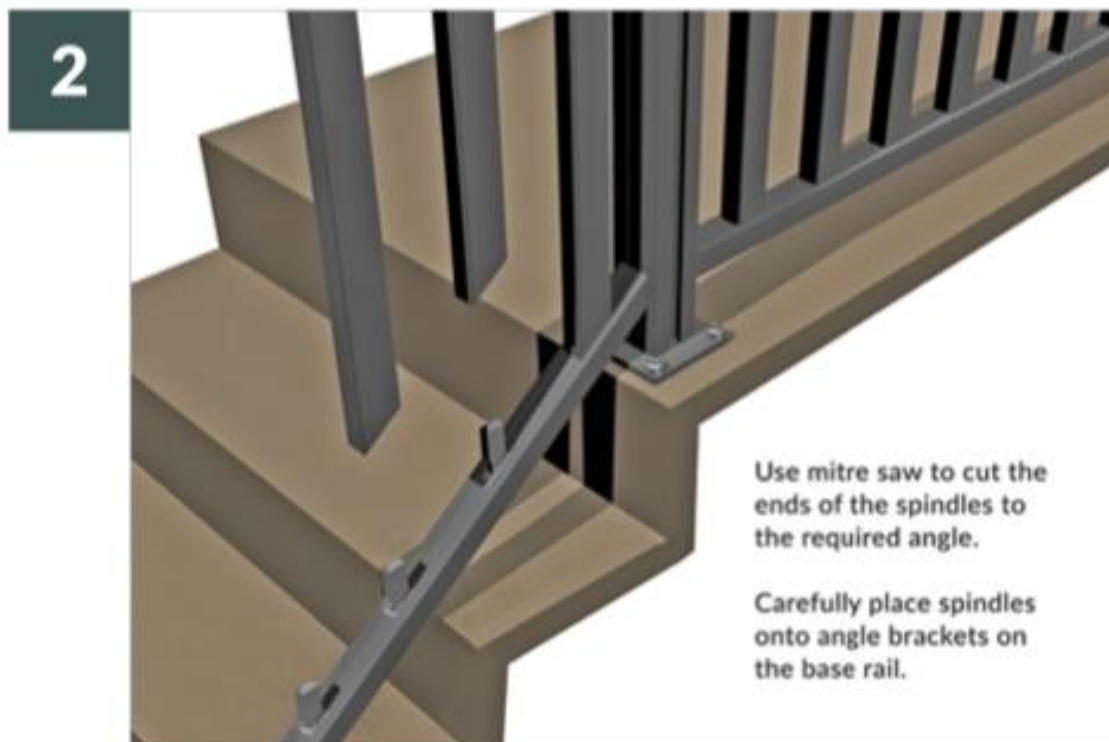
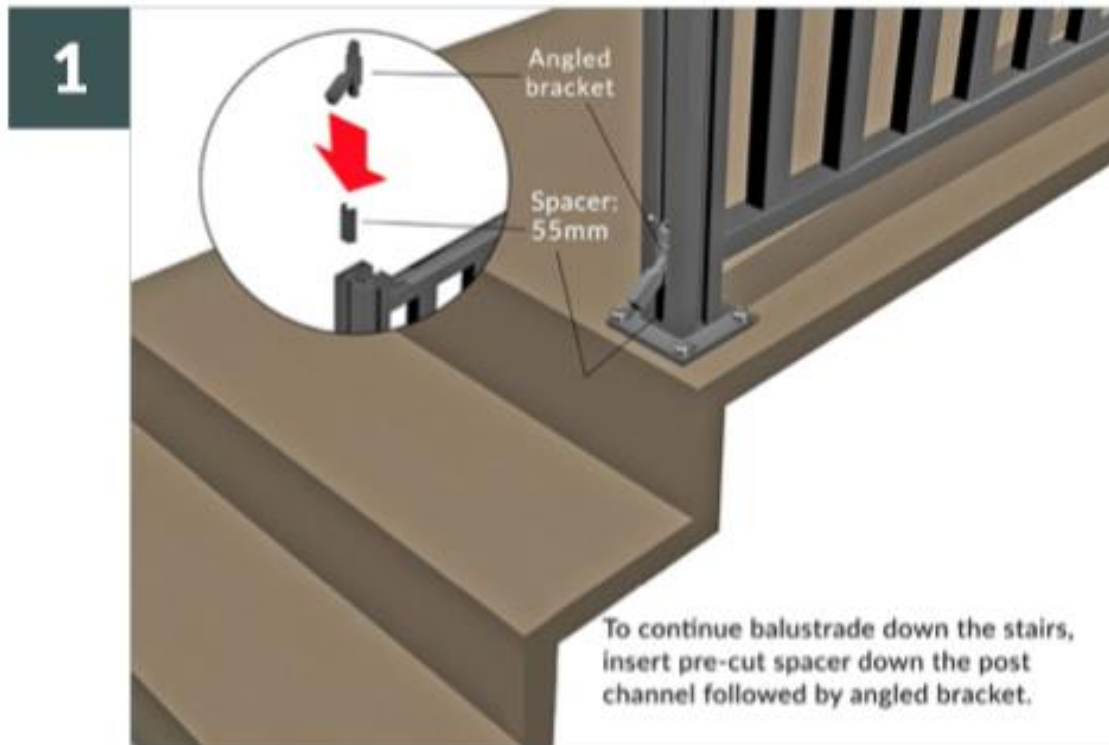

**3**

Make post B in diagram as Step 1 - but do not fix in place.

Long inserts need to be slid down both posts.

Slide angle T bracket into each end of the handrail, then slide down into posts and onto spindles.

Lock T brackets in place with Allen pins and key.

Fit post B in place.

Fit small inserts and post caps.

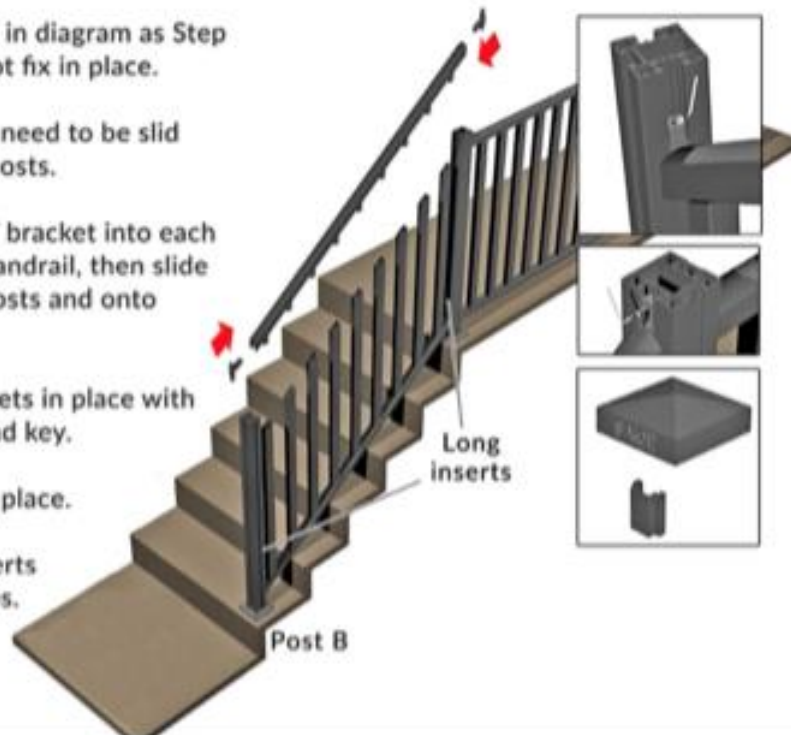

**4**



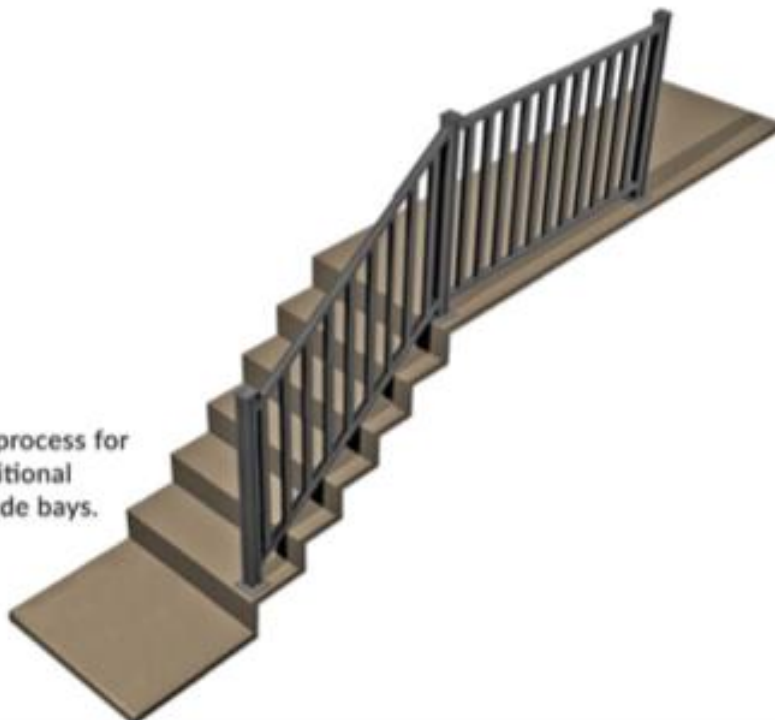



Repeat process for any additional balustrade bays.





## Composite Gates

### Gate Component list

Image	Quantity per bay	Product Description	Dimensions	Weight
<b>Composite Gate FY- G1</b>				
	2	Sides of standard gate	1757mm long	1.5kg
	4	Angled bracket to connect gate extrusion		2kg e.a.
	2	Gate hinge	88mm x 50mm	0.4kg
	1	Bottom Rail	887mm long	0.77kg
	1	Top Rail		
	1 pack	Screws to connect gate extrusions and brackets (one pack contains 16 screws)		0.075kg
	1	FSC 100% Composite Bottom Gate Board	103mm x 824mm x 19.5mm	1.7kg
	10	FSC 100% Composite Gate Boards	145mm x 824mm x 19.5mm	1.9kg e.a.
	1	FSC 100% Composite Top Gate Board	145mm x 824mm x 19.5mm	1.75kg
(See separate drawing in lock packaging)	1	Gate Lock		1.1kg

1



Firstly assemble the bottom half of the gate only.



Connect the aluminium channels to the steel brackets using screws in the pre-drilled holes.

2

Top + bottom boards are different sizes to the rest of the boards.

Standard board height.

Reduced height board for gate BASE (same as top board).

Slide smallest gate boards down aluminium channel, followed by all remaining boards, finishing off with the pre-cut board.

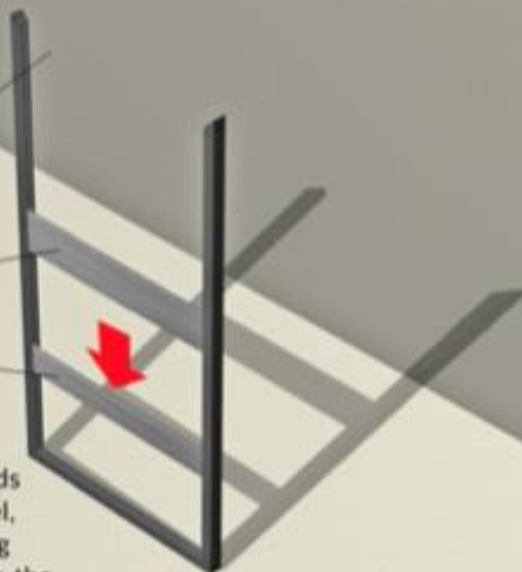



T : 020 8953 6177 • MarkhamClose  
E: enquiries@arbourlandscapesolutions.co.uk  
www.arbourlandscapesolutions.co.uk

3

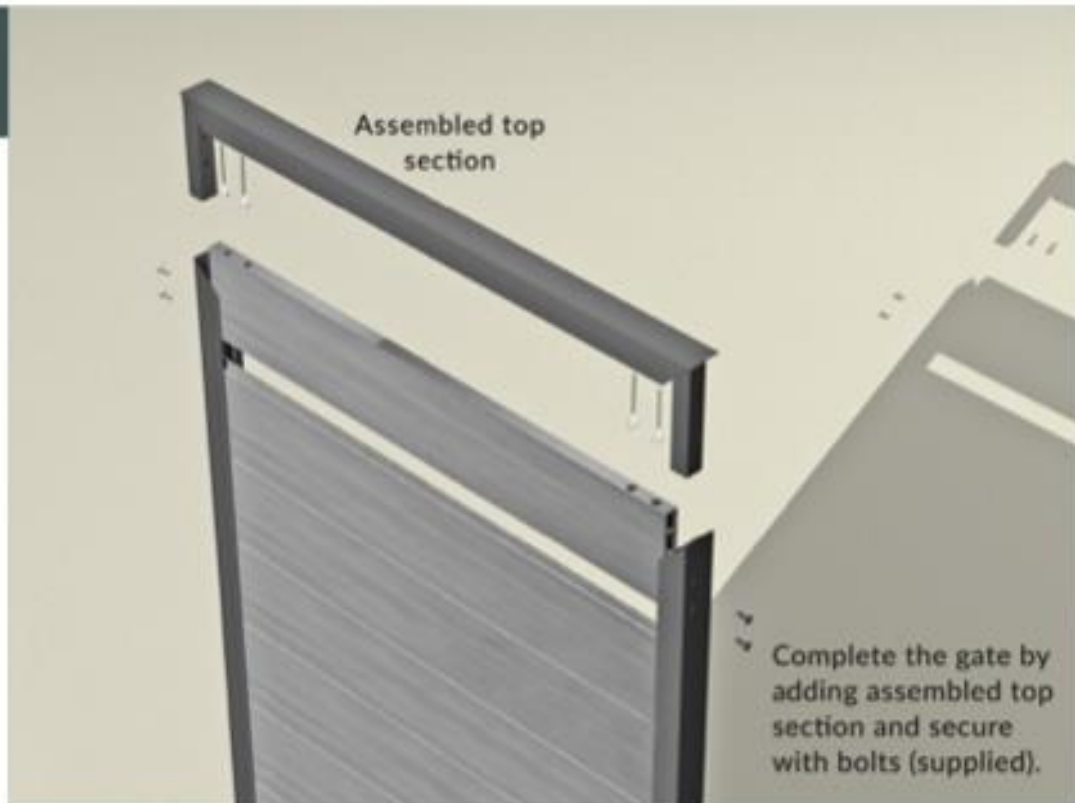

4

1 - Insert hinge assembly down post



2 - Line hinge up with required gate height



3 - Followed by long insert



4 - Insert second hinge at top followed by short insert and post cap

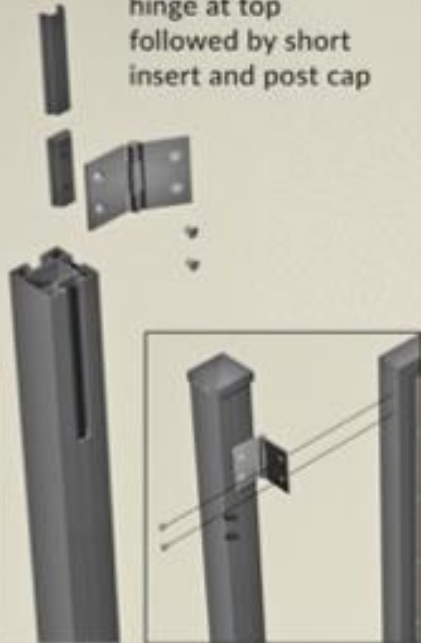

5

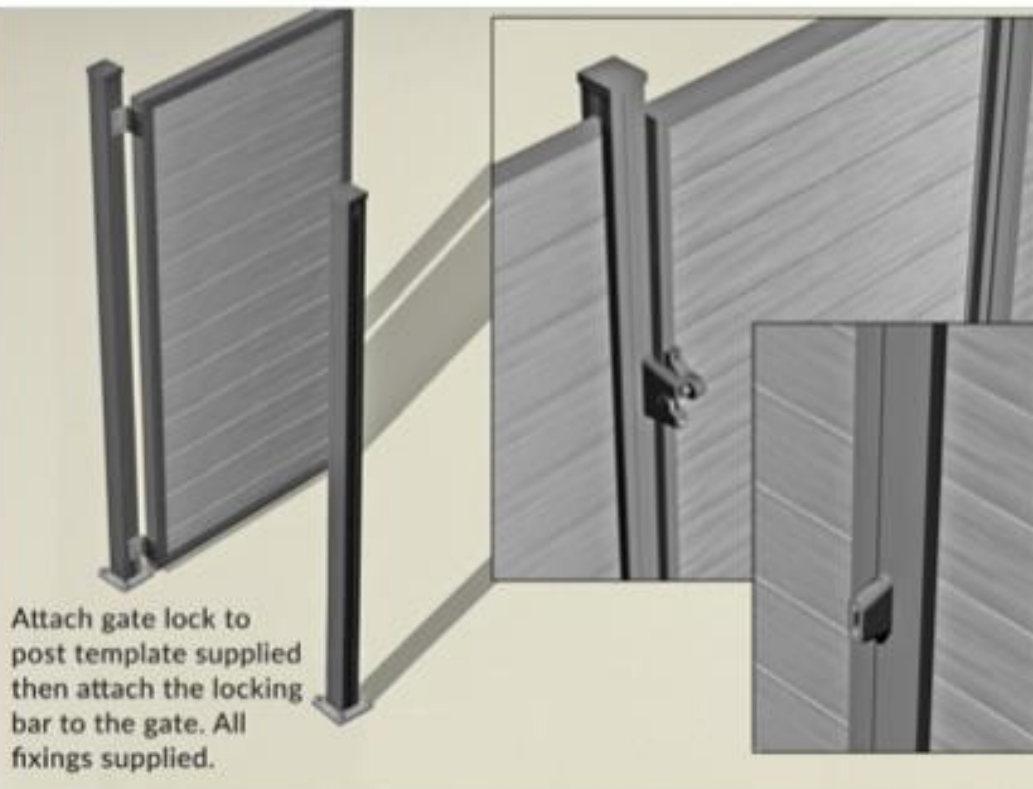

Attach gate lock to post template supplied then attach the locking bar to the gate. All fixings supplied.



T : 020 8953 6177 • MarkhamClose  
E: enquiries@arburlandscapesolutions.co.uk  
www.arburlandscapesolutions.co.uk

6

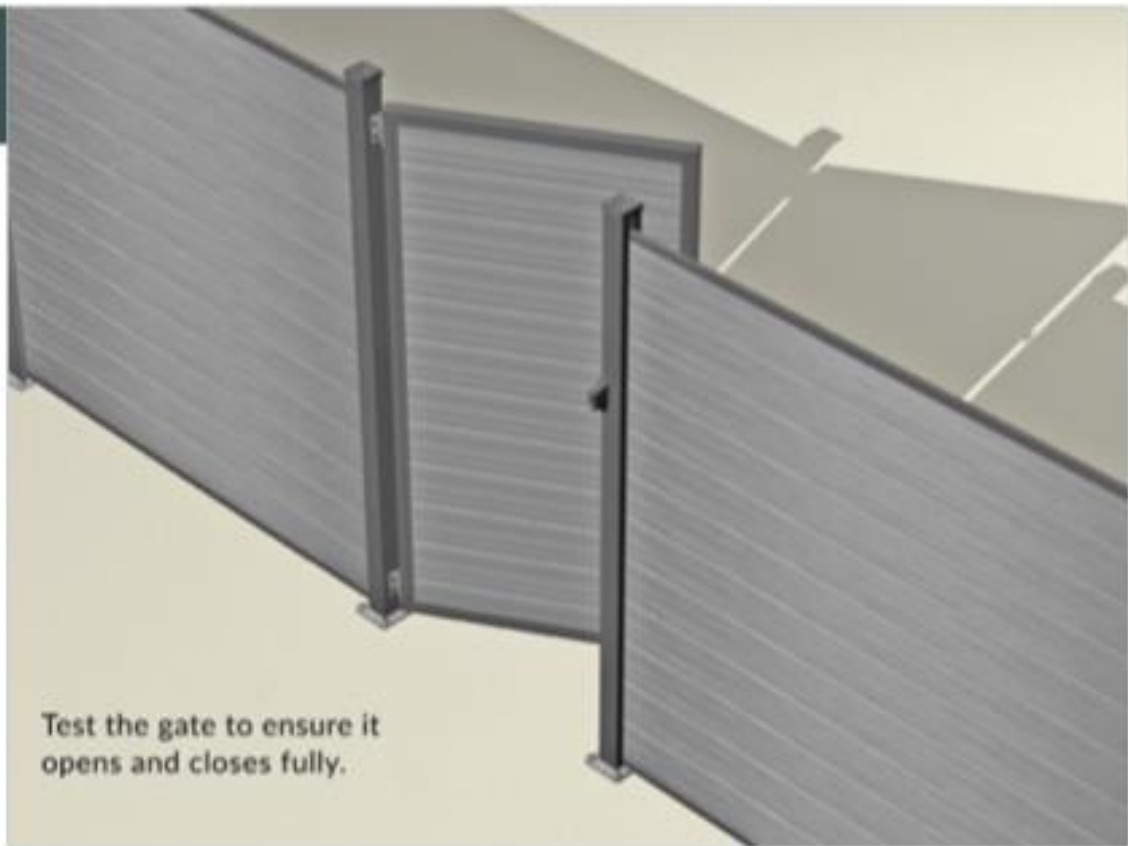

Test the gate to ensure it  
opens and closes fully.