



Composite Products

Longlife Decking | Longlife Fencing

Arbour Landscape Solutions Aluminium Subframe suitable for commercial and residential projects.

The High Strength, High Specification system that offers peace of mind. The easy to install design is not compromised whilst offering the ultimate support solution.

Subframe System installation guide 2020

The Arbour Landscape Solutions Subframe system is easy to install whilst offering maximum strength and durability. Please ensure installation is followed as per the Installation Guides. For Arbour Landscape Solutions Decking installation please refer to the Arbour Landscape Solutions Decking Installation Guides. For any clarification or information please contact a member of the Arbour Landscape Solutions Team on +44 (0) 208 953 6177 or email enquiries@arburlandscapeolutions.co.uk



Frame using pedestals

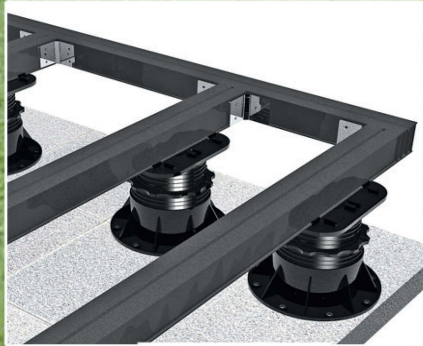

Corner brackets



Frame starts 15mm away from wall

250mm centres

300-400mm centres

30mm gap

300-400mm centres

250mm centres

30mm spacing on double joists when using pedestals

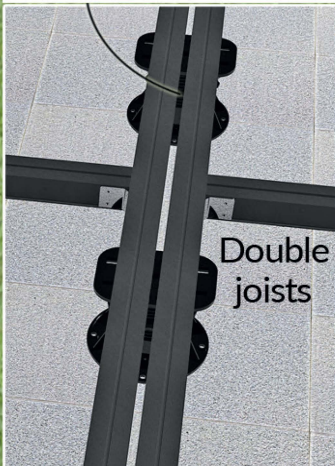

Double joists

Corner brackets (both sides)

Frame supports every 1.8m Connect to joist with corner brackets each side

Joining plates (one each side of joist)

100mm air flow must be allowed on at least two faces



Strip assembly 1

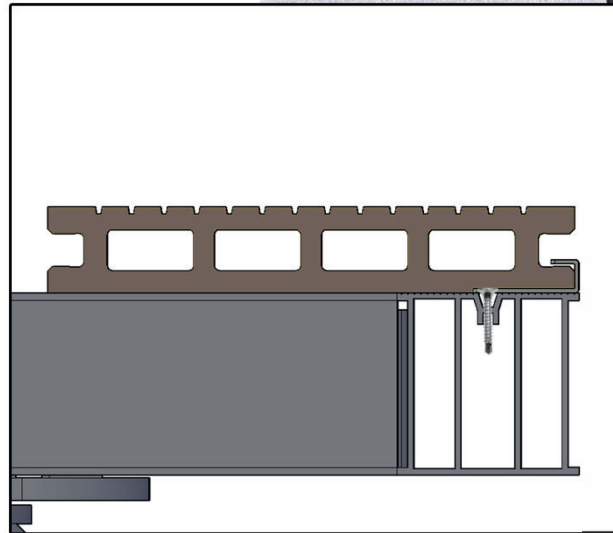
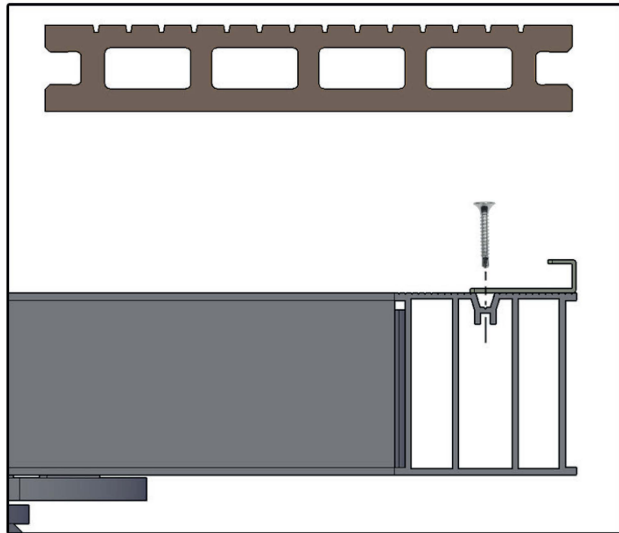
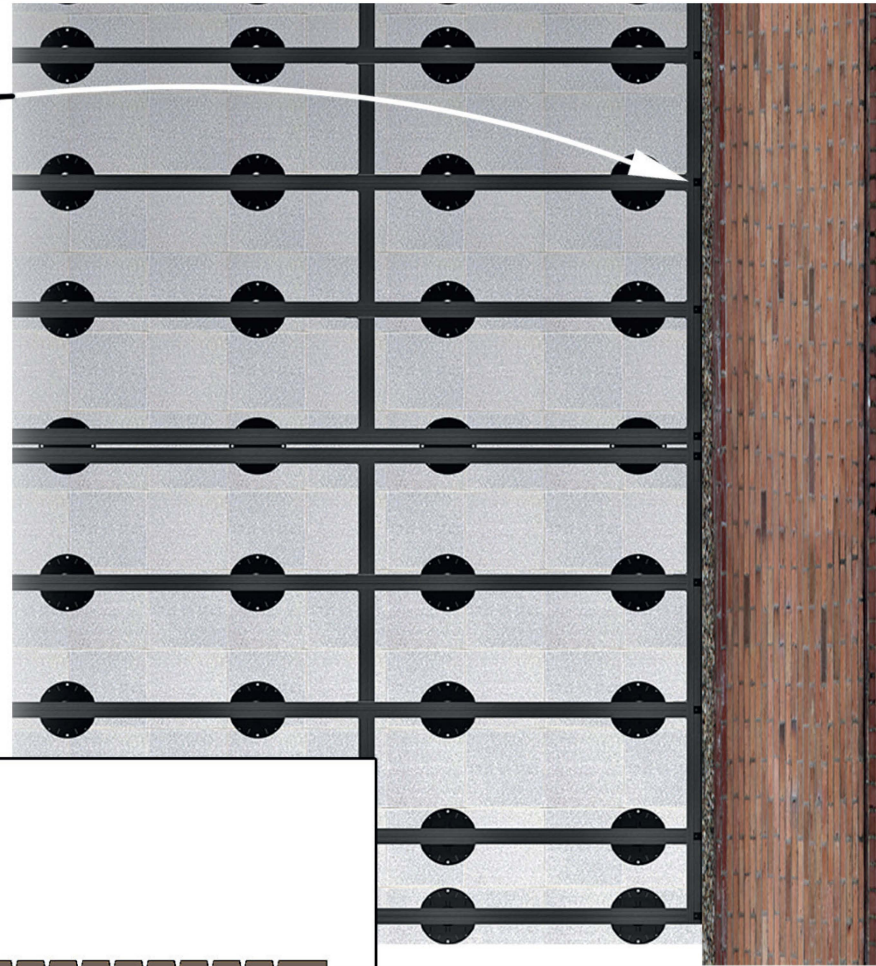
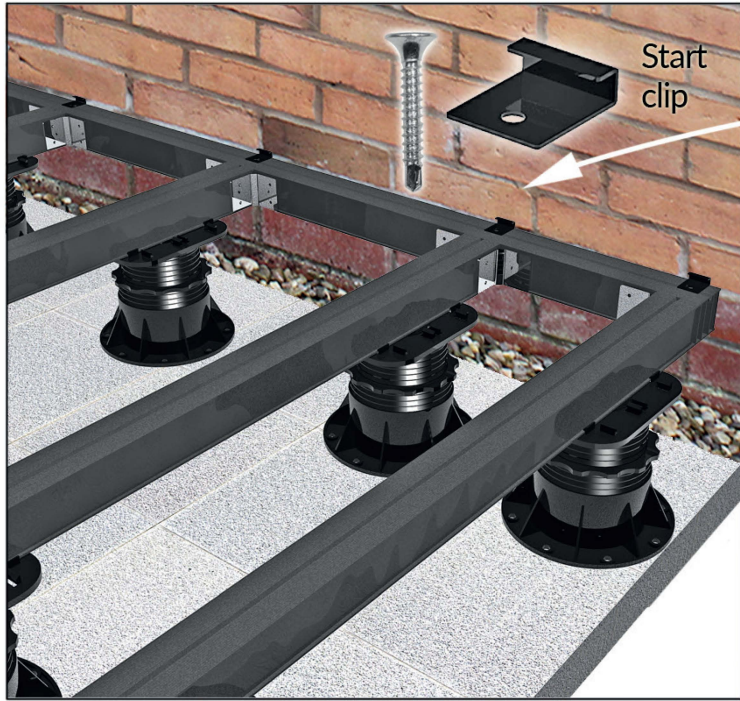

Strip assembly 2

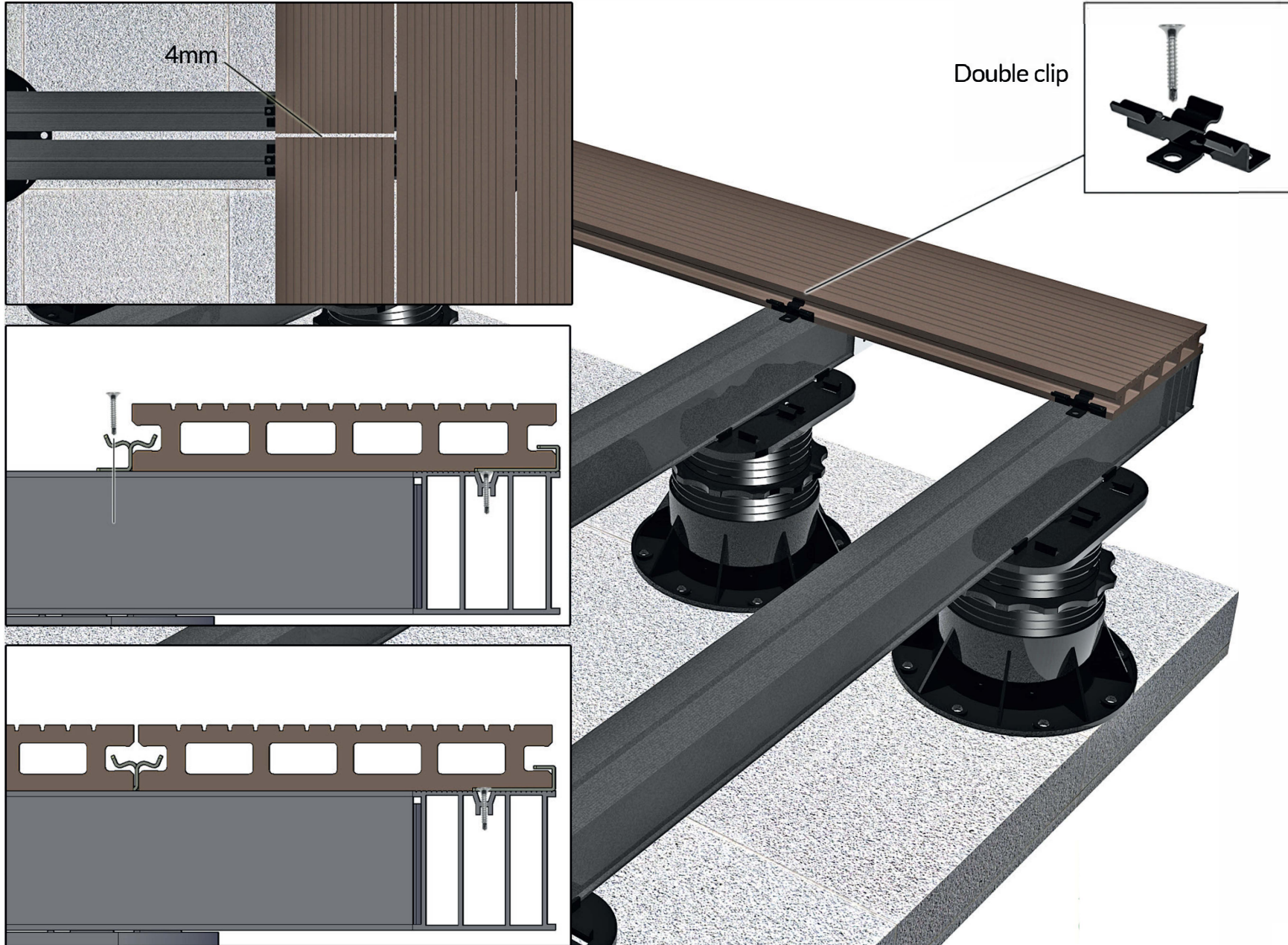

Strip assembly 3

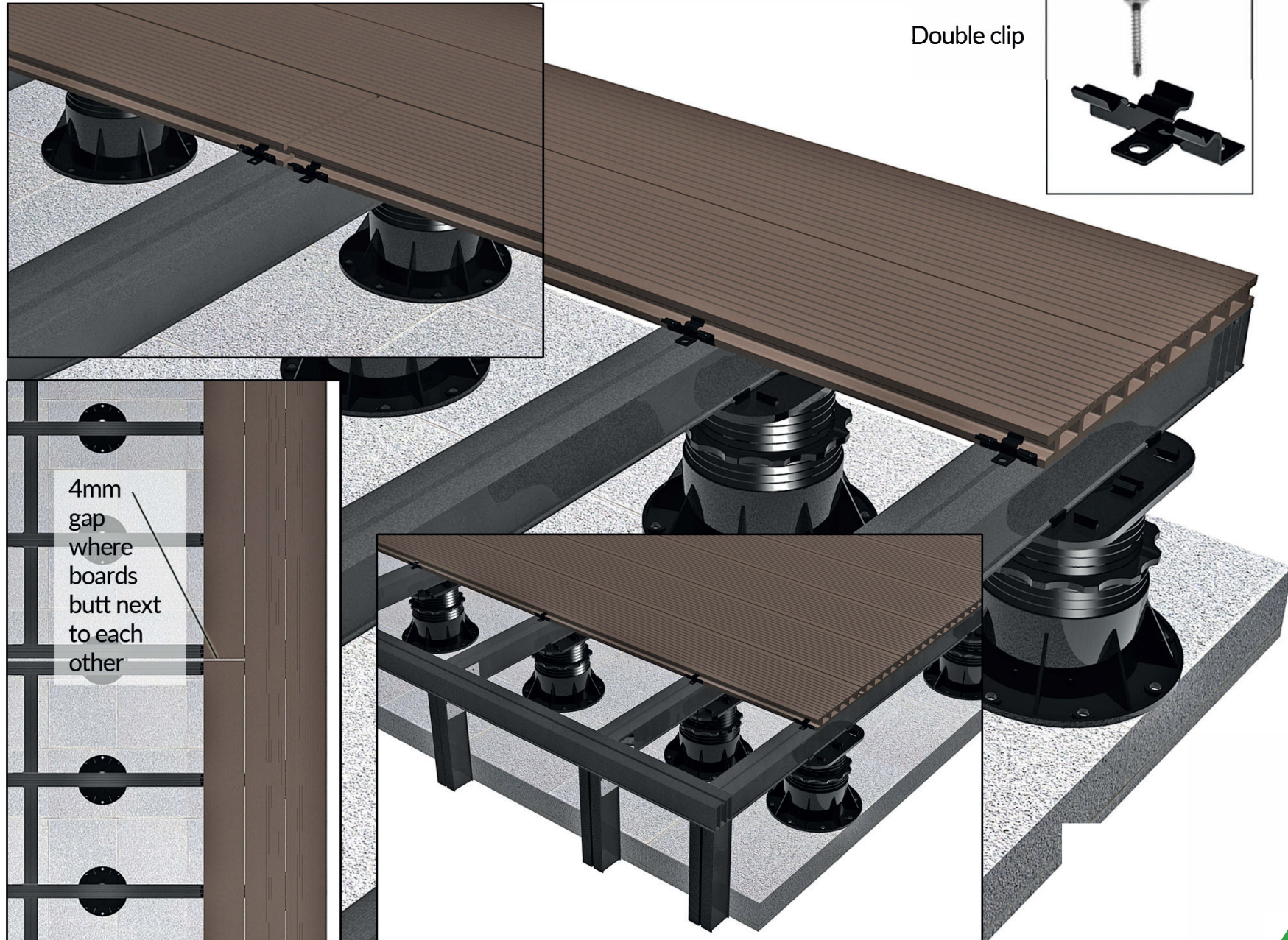

Final assembly

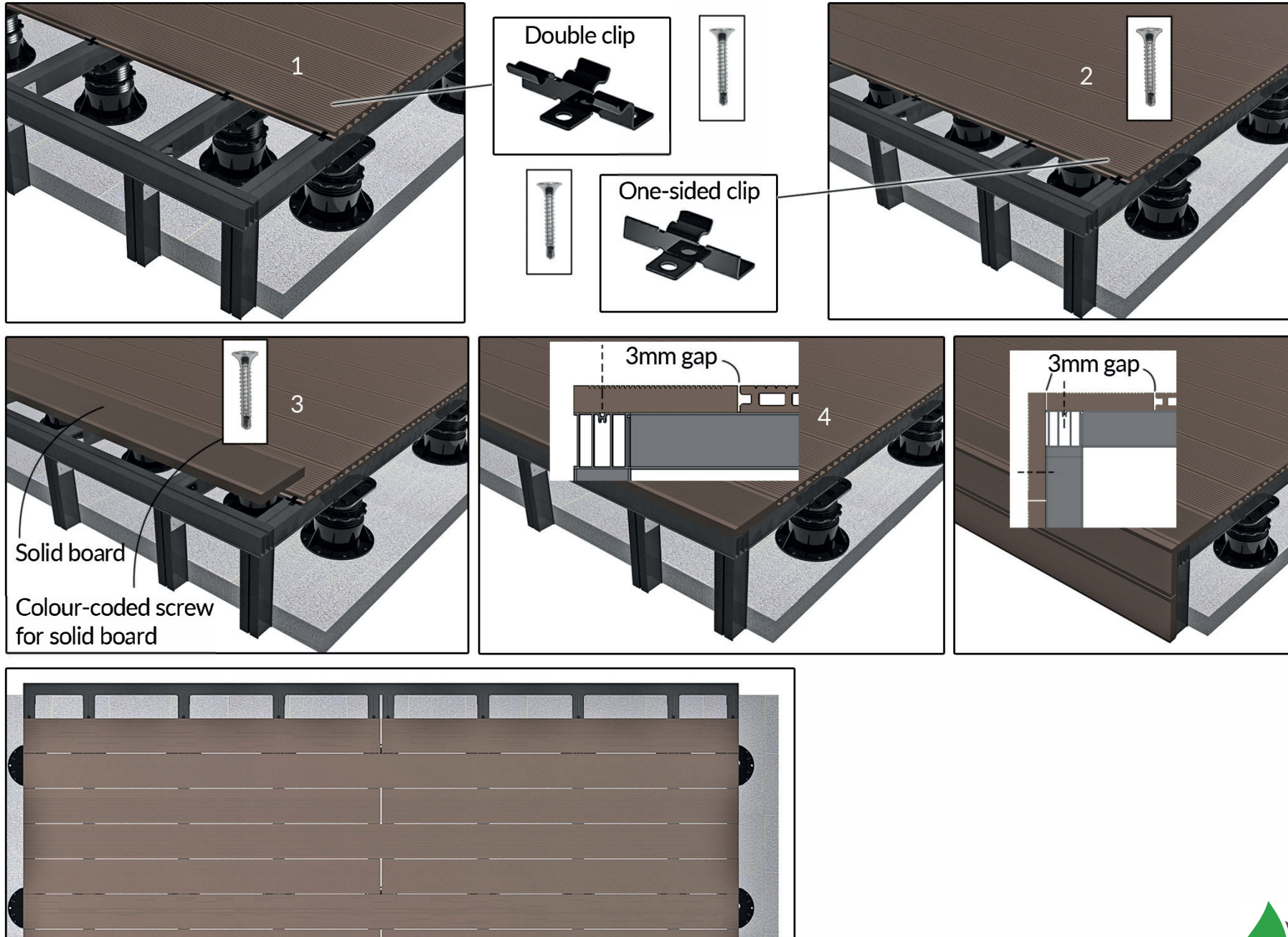

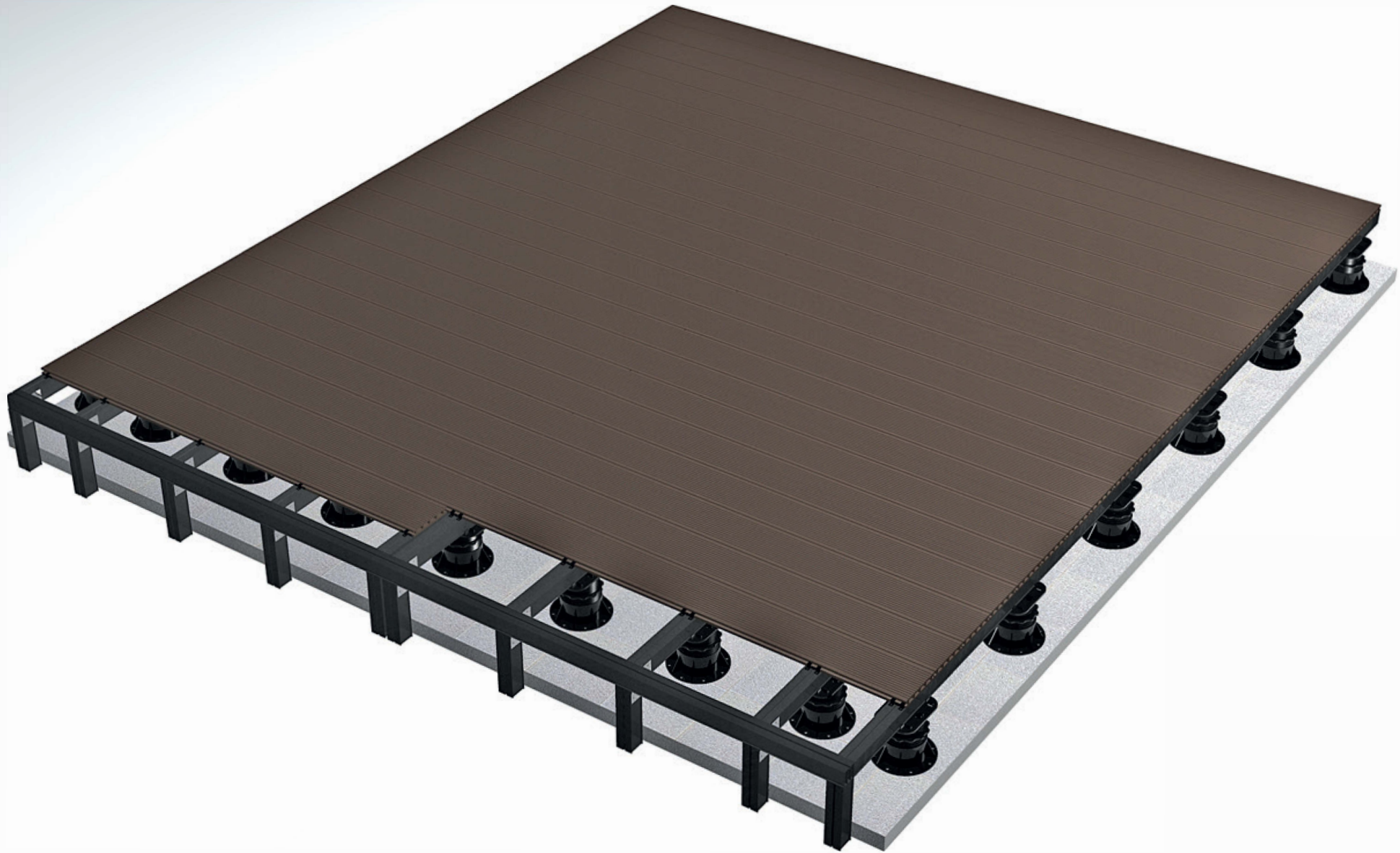

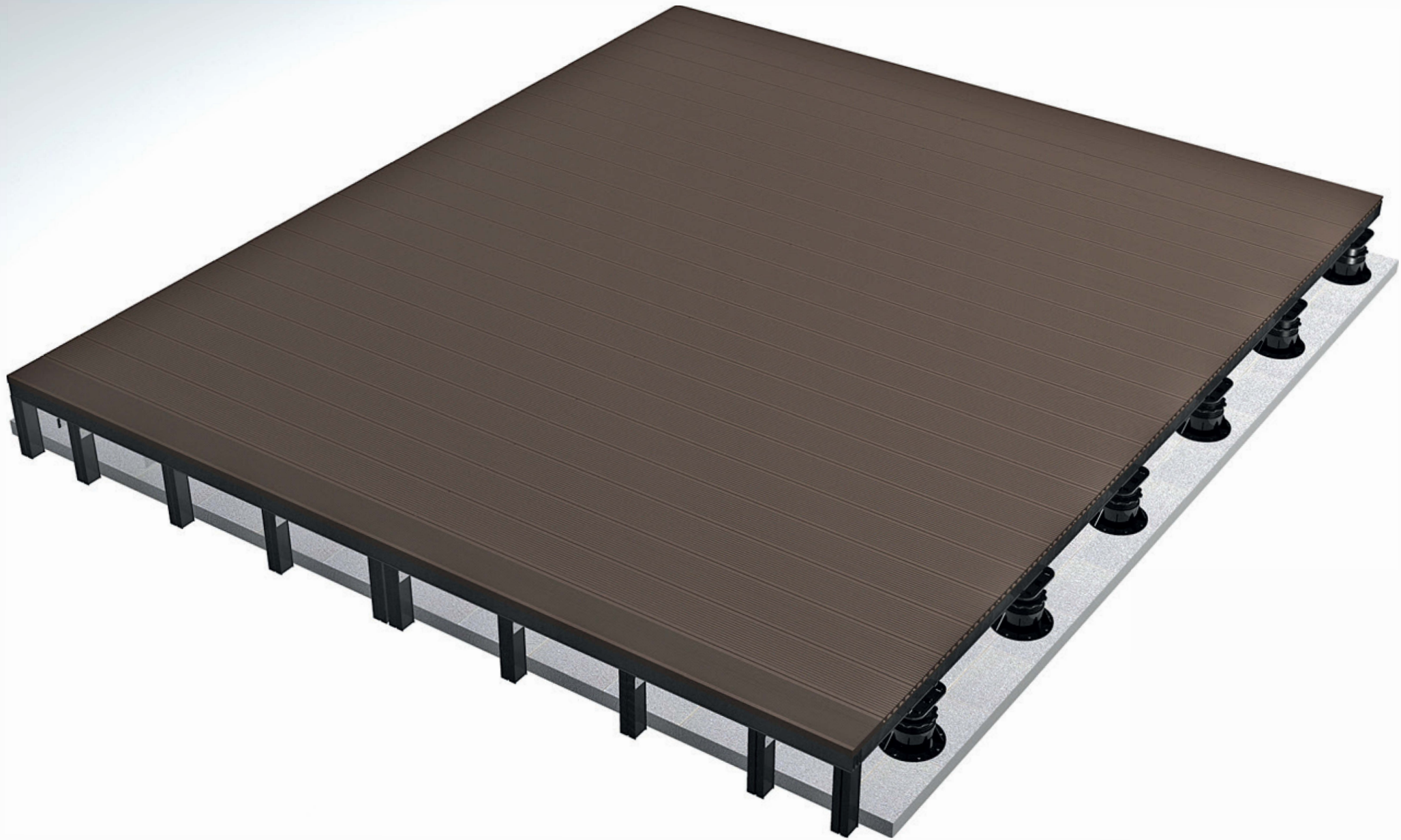

Frame using small and large cradles

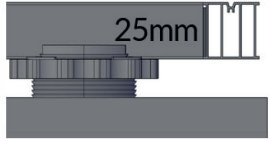

Small Cradle:
43-67mm (incl. 25mm joist)
68-92mm (incl. 50mm joist)

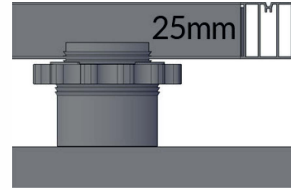

Large Cradle:
87-112mm (incl. 25mm joist)
112-137mm (incl. 50mm joist)

- Corner brackets
- Orientation
- Uneven surface bearers:
Same as for pedestal
installation

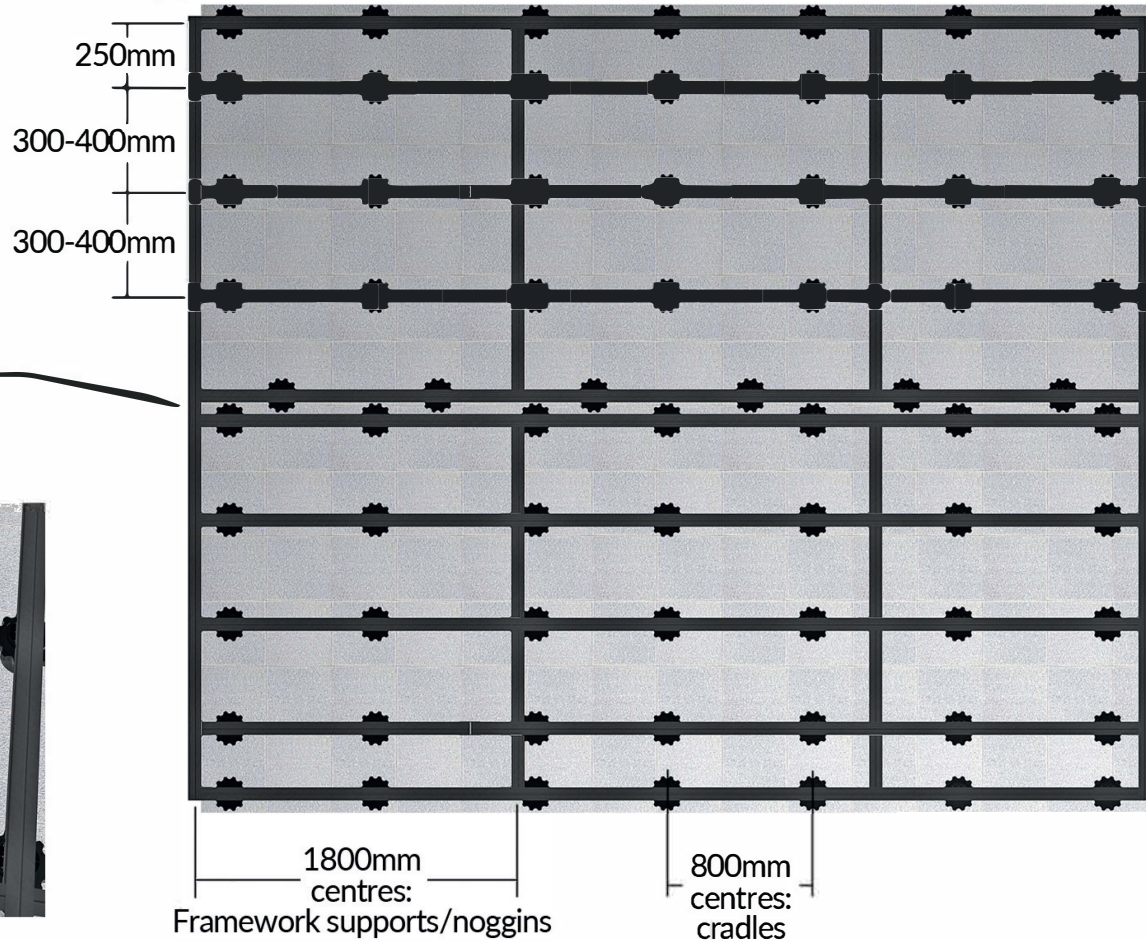

Spacing for
double joists
on cradles: 50mm

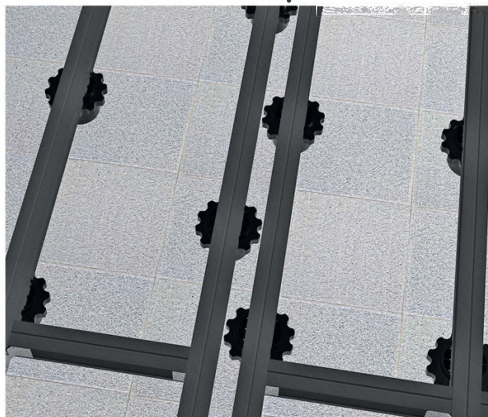

Optional Fascia finish



Additional uprights to act as spacers



NOTE!
Bases of pedestals may need trimming

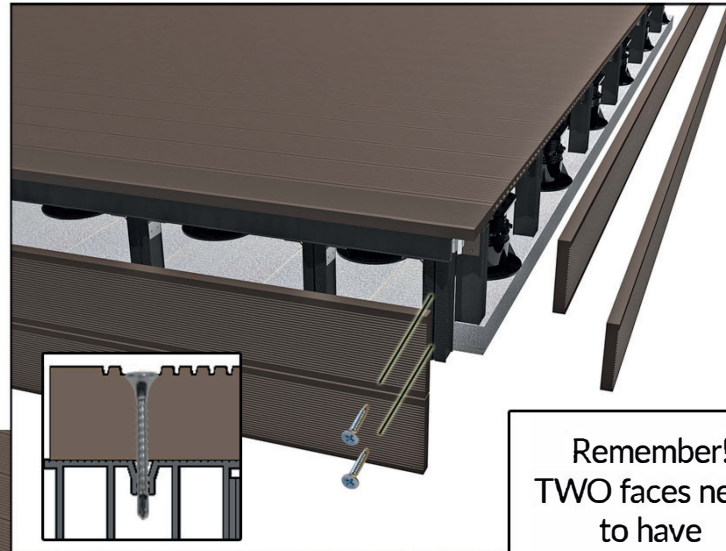

Remember!
TWO faces need to have
100mm air gap

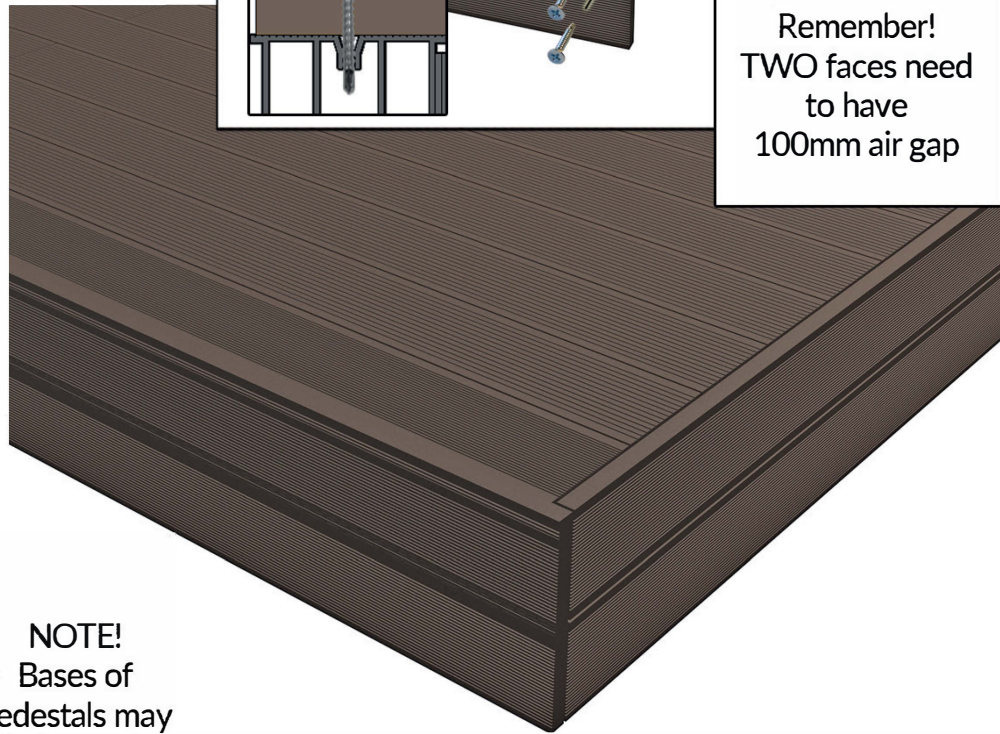

Arbour Landscape Solutions Subframe System - Installation guide with Cradles & Pedestals

1. Lay the main joists in the opposite direction to decking, spaced at:

- First and last joist spaces = 250mm centres
- General joist spacing = 300mm – 400mm centres
- Where boards join leave approx. 10mm gap between joists – ensure joists align to fit cradles underneath where double joists are placed before securing frame – see diagram on page 10

If creating a border with Arbour Landscape Solutions Solid boards, place additional joists vertically on either side of the frame, to the width of Arbour Landscape Solutions solid board and then space first and last joist at 250mm. Cradles can be staggered either side along the joist

2. Place an adjustable cradle / pedestal; at each end of the joist, including double joists, to ensure correct spacing is left between them before connecting framework with applicable connecting brackets.

3. Place and adjust the cradles to level up the substructure as per guidelines

below. **Cradles/Pedestals must be spaced as follows:**

- For 25mm joist substructure - 800mm along the joist
- For 50mm joist substructure – 800-1000mm along the joist

4. Connect main joists lengths together end-on-end using Arbour Landscape Solutions flat connector brackets and Arbour Landscape Solutions screws provided.

- Leave a 4mm expansion gap between all joist profiles

5. Lay perimeter joists horizontally to the main joists at the ends and connect lengths together where applicable using Arbour Landscape Solutions flat connector brackets and Arbour Landscape Solutions screws provided.

- Leave a 4mm expansion gap between all perimeter joist

6. Connect main joists to perimeter joists using Arbour Landscape Solutions angled connector brackets and Arbour Landscape Solutions screws provided, ensuring correct spacing between main joists is maintained.

7. Insert joist supports/noggins as required to support frame - recommended every 1.8m along the joist. Connect to the main joists either side using Arbour Landscape Solutions angled connector brackets and Arbour Landscape Solutions screws provided.

n All joins where joists butt up next to each other must be supported by a cradle / pedestal

8. If downturns are required, cut vertical profiles to required length, and connect to outer joist using Arbour Landscape Solutions angled connector brackets and Arbour Landscape Solutions screws provided.

- Connect the lower end of the vertical profiles onto the joist, or on the securely placed concrete blocks/pad stones, using Arbour Landscape Solutions angled connector brackets
- To create steps in the deck area, line up the differing level deck areas, then create a downturn from the higher-level deck and connect onto the lower-level deck by using the joists in a cube effect and use Arbour Landscape Solutions Angled connectors as applicable

9. Where double joists are required, ensure a minimum gap of 50mm is left between these joists when using cradles. These will need to be staggered along the double joists to enable adjustment of cradle to the desired level. Please note, if using pedestals then a 30mm gap is required, which, when clicking the 2 joists onto the top of the pedestal a 30mm gap is naturally left anyway. (See Diagram on page 10)

10. Install decking in accordance with Arbour Landscape Solutions Decking Installation guide, using Arbour Landscape Solutions Decking clips / colour coded screws to fix the decking to the substructure.

****NB** Please note dependant on temperature when installing decking boards will determine gap to leave where boards butt up next to each other – please see information in the Arbour Landscape Solutions Decking Installation guide for more detail****